

SLIDO



WiFiConstruction-Guest

This WiFi network is for guest access. To connect you go through a verification process. You enter your mobile number and you will receive a verification text. Enter the verification code to gain access to the internet. This network will have no access to any local network resources.

After verification you will receive an email with a username and password. This can be used to re-authenticate to the network if for example you go for lunch and disconnect from the guest WiFi.

The guest WiFi sessions last for 8 hours only per day.

- Open Browser
- Navigate to www.Slido.com or just install the Slido App
- Enter the event code #B839

Harwell

NucSIG event

Project Quality – “What
is important about
Project Quality in the
Nuclear Sector – Session
Two?”





Welcome,
introduction &
domestics

Amanda McKay

Quality Director Major Projects/Nuclear Quality
Director

Balfour Beatty

Chair Nuc-SIG



Nuvia
introduction
and scene
setting

Kris Bradshaw
Marketing Director
Nuvia

Nuvia is part of VINCI: The world's leading construction & concessions company

2017





39.8 bn €



193,468



-  Vinci is the largest construction & concessions company in the world
-  Vertical integration allows us to provide turnkey solutions and supporting operations
-  Nuvia is the Nuclear arm of VINCI, providing international capability

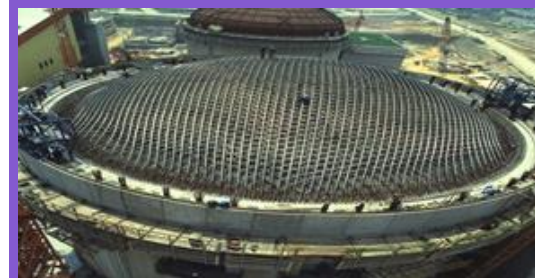

Contracting
32.8 bn €

Concessions
7.0 bn €

Working in Nuclear: The Safe Way is the Only Way



An unparalleled health & safety culture
Recognised beyond the nuclear industry,
by the most influential Health & Safety
organisations in the UK



Nuvia's Quality Culture: Leading the way

A best in class Quality Culture is a perpetual goal



9001:2015

One of the first in our sector to transition to ISO 9001:2015 with our third party certification body – Lloyds Register

Partner of the CQI

One of the first Nuclear specialists to be granted Partner status with Chartered Quality Institute

CQI Competency Framework

Our experts helped shape this framework and the Learning and Development framework which supports it.

Nuvia Group

Supporting the full Lifecycle

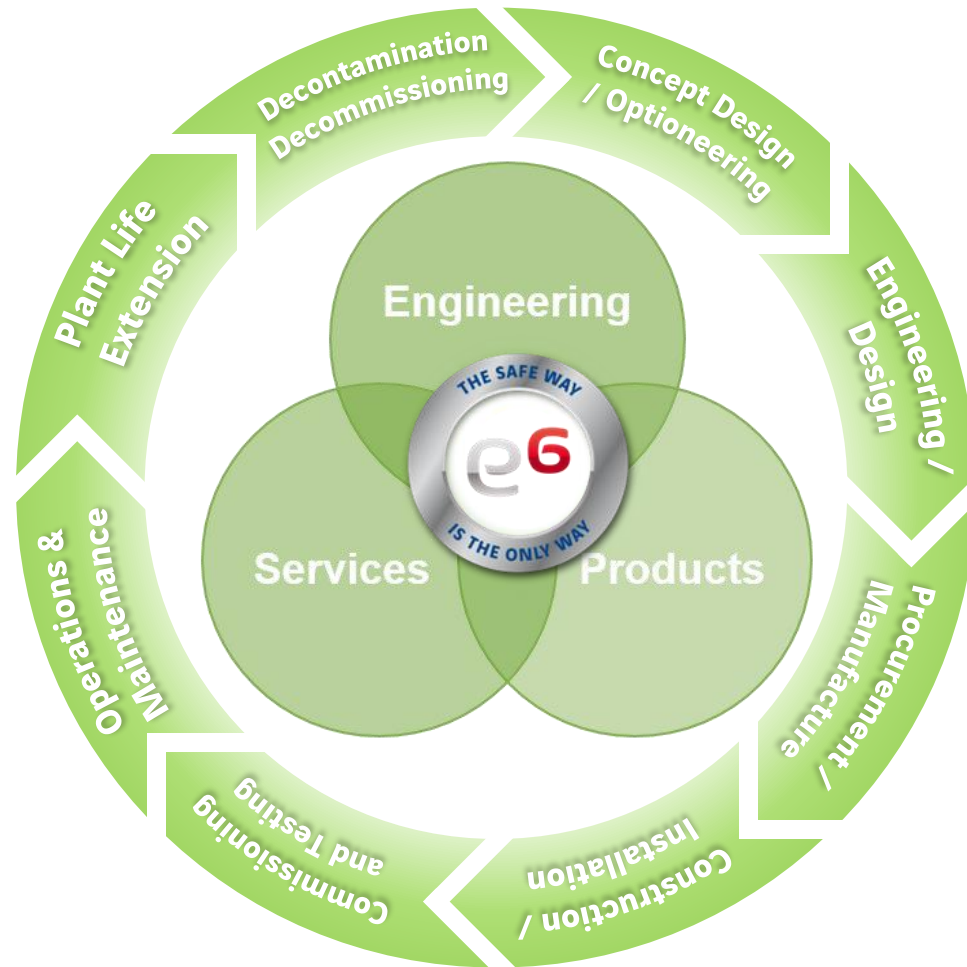

Key Areas of Activity:

-  Consultancy
-  Design and Build
-  Plant Life Extension
-  Operations and Maintenance
-  Decommissioning
-  Radiation Protection
-  Waste Management
-  Products

Capabilities

Full Lifecycle

Project Management, Engineering and Consulting: 450

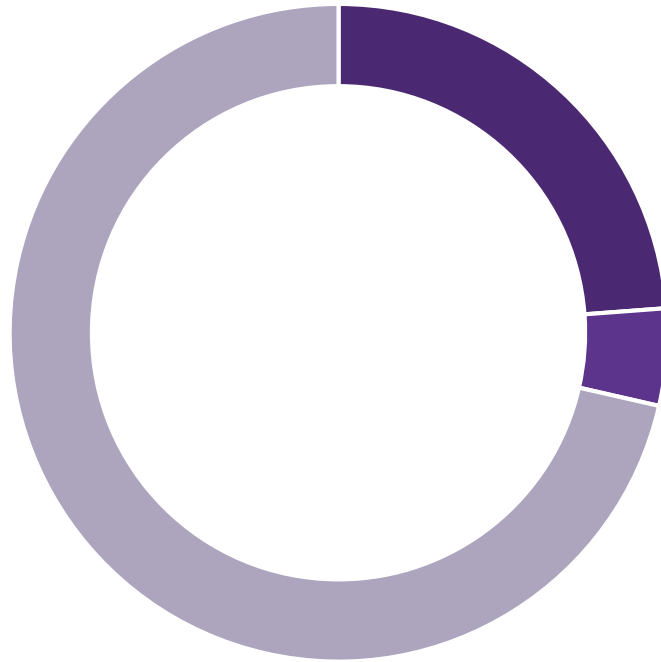

■ Project Management ■ Quality Assurance ■ Engineers and Scientists

Operational Services: 400

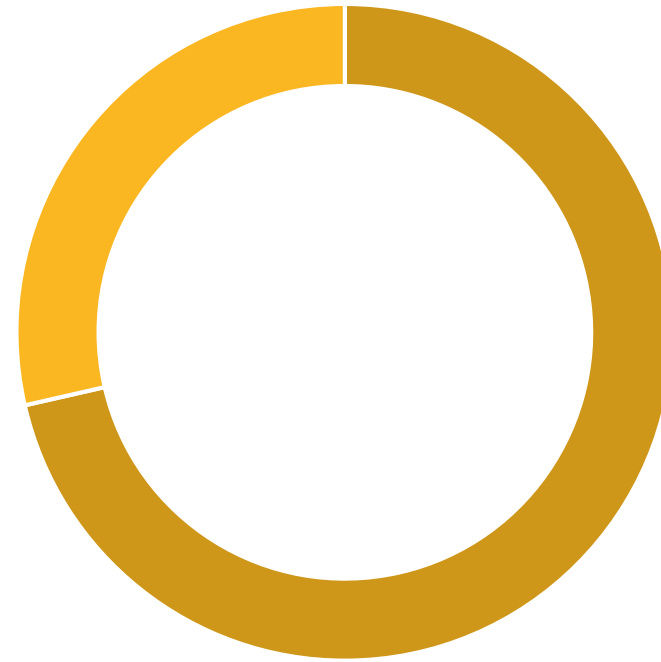

■ Health Physics Specialists ■ Operations Team ■



Stack Demolition: Self Climbing Platform

Planning and undertaking the decommissioning of the highest stack at Sellafield, in the centre of this congested nuclear site

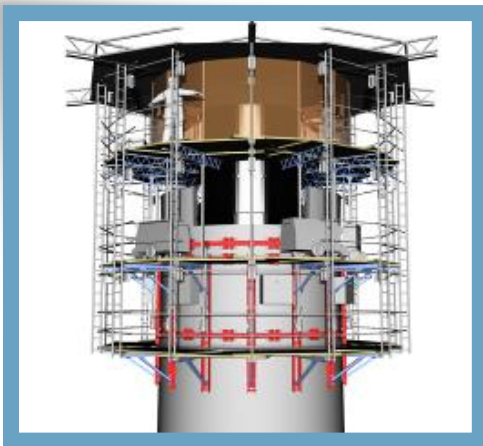

Scope

- Full Engineer Procure Construct (EPC) and 'operate' project
- Design of the method of decommissioning and demolition – full install and erection of the SCP and decommissioning of the stack
- Full scale off site trials of the SCP system

Challenges

- Contaminated stack from fuel reprocessing
- Safe access and egress to platform
- Working at height and adverse weather
- Plant and equipment hazards

Outcome

- Nuvia brought together a group of specialists to offer best guarantee of safety through all project phases
- Platform erected at off site test facility; installation and initial commissioning at Sellafield site completed.
- First project in a generation to retire a Category A risk on the Sellafield site by reaching the 47m mark in Jul 18
- Decommissioning continues to progress ahead of schedule



Planning and undertaking the decommissioning of the highest stack at Sellafield, in the centre of this congested nuclear site



East Side Curtilage Land Remediation Project



Scope

- Main Contractor to prepare the site to allow for future “de-designation” under the Energy Act
- Safe excavation of vegetation and concrete slab.
- Excavations to remove chemical and radiological contamination.

Challenges

- Nuvia managed a number of new sub-contractors on an unfamiliar site.
- Avoid any impact on the availability of key electrical services; an 11kV cable traverses the ESC site.
- Avoid any impact on the availability of surface water drains; 450mm dia pipes traverse the ESC site.



Outcome

- Throughout the duration of the project, there were Zero Lost Time Accidents and RIDDOR's.
- Both the final Chemical and Radiological de-designation reports were accepted by the Client at the first iteration.
- As a summary for the project, 4,850 bags were HIRAM'd, with 26% Out of Scope, 74% In Scope.

East Side Curtilage Land Remediation Project, Capenhurst

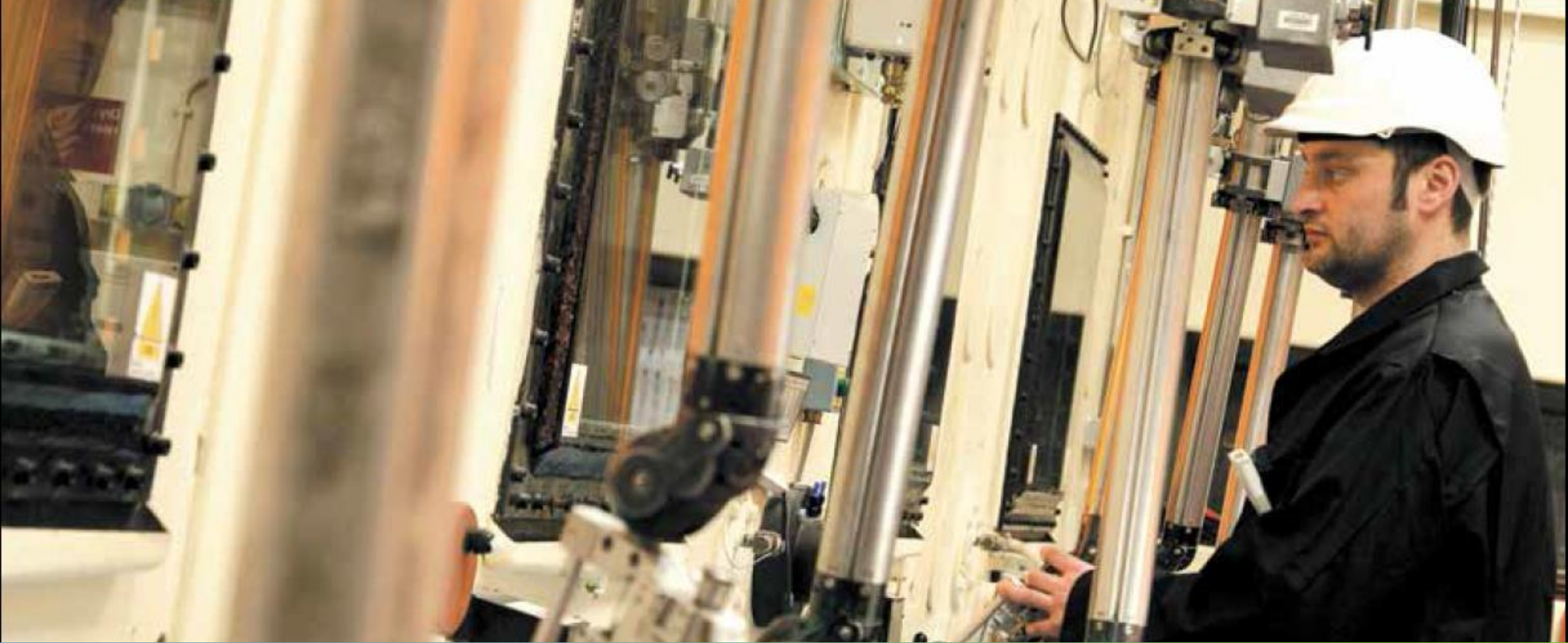

NNL Engineering Support

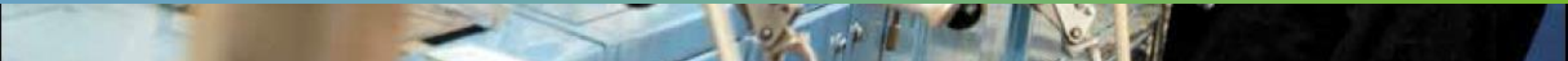



Scope

- Provision of Engineering Services support through the NNL Engineering Design Framework
- Engineering resources covering:
- Engineering Design
- Project Engineering
- Quality Engineering
- Working within NNL Central and Windscale Laboratories at Sellafield

Challenges

- Integration of resources within existing client team
- Resource smoothing to cover skillset gaps to support client and stakeholder project delivery expectations
- Pick up existing design on live projects
- Management of NNL sub-contractors to ensure required quality is achieved

Outcome

- Reduction of historic programme delivery risk in Windscale Lab
- Acceleration of Design for Central Lab – HIP project
- Increased pool of engineering capability available to NNL
- Flexible delivery options providing staff resources with appropriate design software solutions to suit NNL
- Support is continuing into 2019

NNL Engineering Support



Nuclear Security & Shielding Doors, Grids & Blast Dampers



Nuclear Security & Shielding Doors, Grids & Blast Dampers



Scope

- Nuvia with its joint venture partner Sommer Design & Security has been awarded a circa £60m contract to design, manufacture, install and commission the Nuclear Security Doors, Grids and Blast Dampers at Hinkley Point C

Challenges

- In total there is circa 1000 pieces of equipment needed to be manufactured and installed in different buildings around the Hinkley Point C Site
- The doors are complex in nature and help protect the physical security of the plants operation whilst providing protection from a conventional safety perspective

Outcome

- Strong existing relationship on an international scale with our partner Sommer
- Nuvia recognised for its ability to offer a turnkey solution and proven delivery of M&E installation
- Currently in the design phase of this contract

Full turn-key capability to design, procure, install, construct and commission nuclear doors, grids and blast dampers



Dungeness A Waste Transfer Area Facility

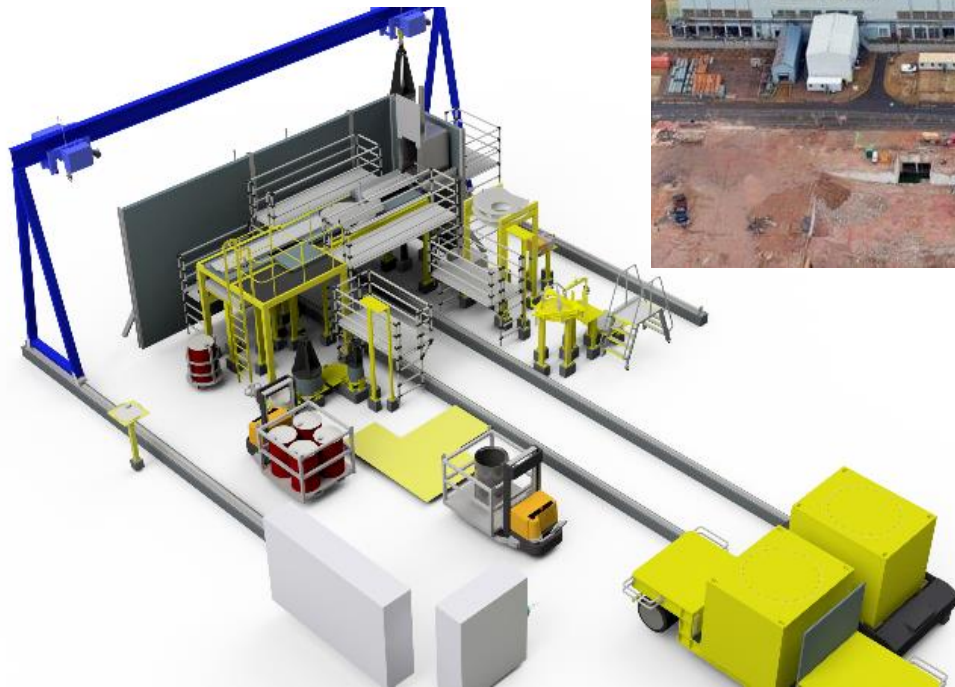

Scope of Work

- EPC contract for the detailed design, procurement, manufacture, FAT, installation, and inactive commissioning of a Waste Transfer Area to enable the repackaging of Intermediate Level Waste.
- Detailed design of all WTA plant equipment.
- Procurement and manufacture of all plant equipment.
- Installation of all plant equipment.
- Inactive commissioning of the WTA.
- Supporting the active commissioning of the WTA.

Challenges

- Due to the high dose rates, manual handling is not feasible thereby requiring long reach tool and remote operations to provide a cost-effective solution.
- 5 different waste streams need to be considered, dependent on the specifics of the ILW needing to be transferred.
- Many variations, flexibility of plant and equipment is required.
- All the equipment needs to be configured within building confines

Outcome

- Project recently started
- The design phase of the project is scheduled to take 9 months, with an overall project forecast of 20 months.

Dungeness Waste Transfer Area Facility
Location: Dungeness A Power Station



Advanced Modular Reactors (AMR) Technical Advisor to UK Government

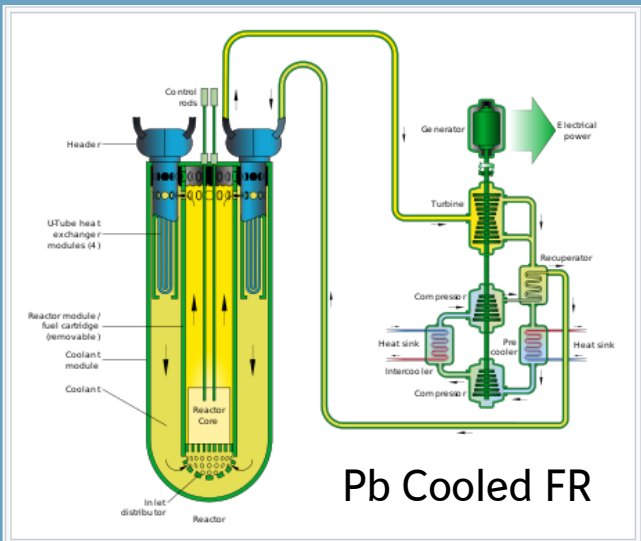

Pb Cooled FR

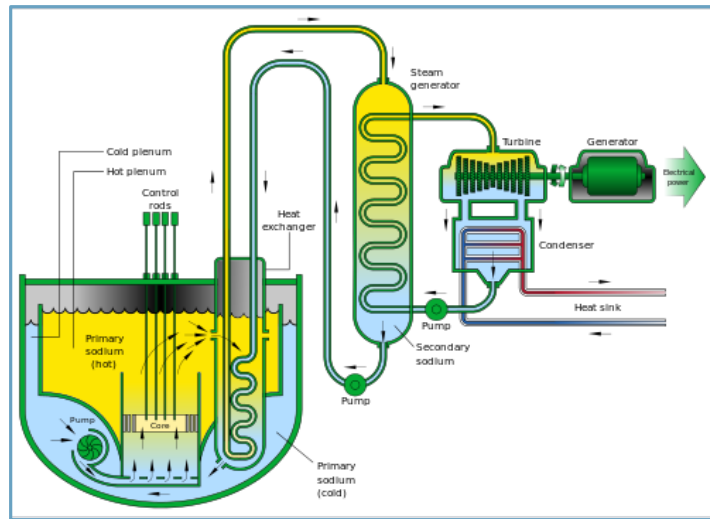

Scope

- Provision of Technical Advice to the Department for Business, Energy and Industrial Strategy (BEIS) for their Advanced Modular Reactor (AMR) Feasibility and Development Project
- Charing meetings to provide advice and guidance to the 8 AMR vendor design teams
- Technical assessments of the 8 AMR designs

Challenges

- New and novel reactor designs involving many different technologies and assessment of the detailed description of the designs
- Several different applications for the reactors e.g. electricity generation, heat generation, hydrogen production and fusion.
- Assessment of design maturity against US DoE Technical Readiness Assessment Guide (TRA)
- Assessments of R&D plans and cost and commercialisation plans

Outcome

- Project started in Q3 2018.
- Final reports submitted in March 2019.
- Positive feedback from Government.

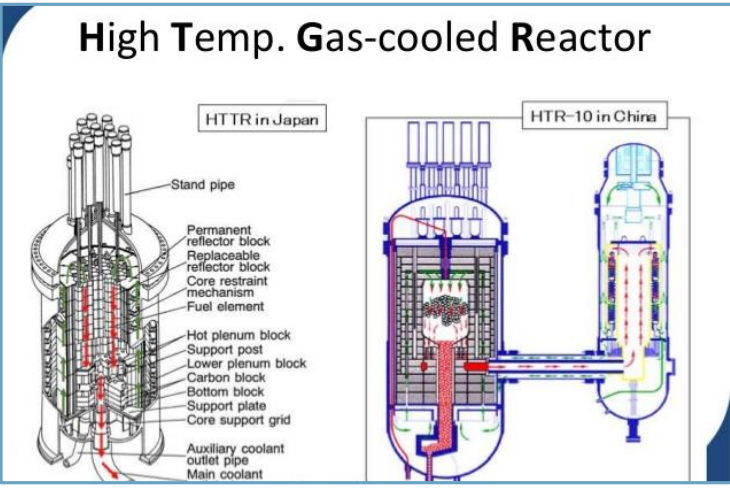

Fusion

- Advanced Reactor Concepts LLC – ARC 100.
- DBD Limited (Unnamed technology vendor).
- LeadCold – SEALER.
- Moltex Energy Limited – Molten Salt Reactor.
- Tokamak Energy Ltd – ST40 Fusion Reactor.
- U-Battery Developments Ltd – U-Battery.
- Ultra Safe Nuclear Corporation – MMR-X.
- WEC UK Limited – Lead-Cooled Fast Reactor (LFR)

Advanced Modular Reactors (AMR) Technical Advisor to UK Government



New Safe Confinement at Chernobyl Nuclear Power Plant
Nuclear Aspects



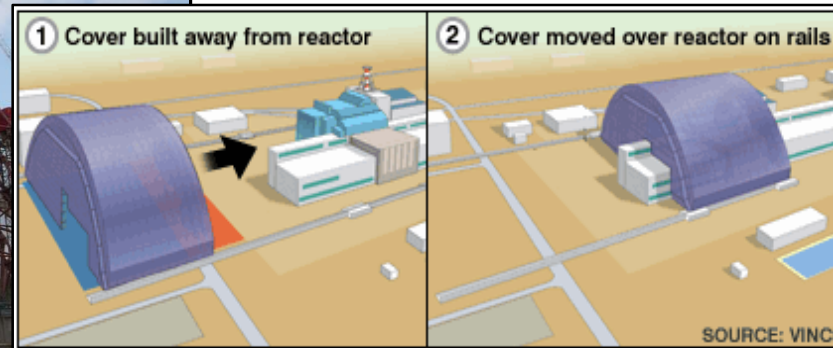

Scope

- Safety and Design Reviews
- Waste Management
- Seconded Staff in Paris and Ukraine
- Radiological Protection / Health Physics

Challenges

- Performing work at the site of the world's worst nuclear accident
- Long term effect of radiation field on materials
- Delivering one of the largest nuclear projects in the world

Outcome

- Nuvia delivered work as part of a combined team designing and constructing a new safe confinement for the world's worst nuclear accident

New Safe Confinement at Chernobyl Nuclear Power Plant

Nuclear Aspects



NUVIA



Kris Bradshaw, Marketing Director



Nuvia UK



+44 (0)1925 867 179



kris.bradshaw@nuvia.co.uk



www.nuvia.co.uk



Managing and
Delivering Project
Quality for a large
Nuclear Project

Tim Shuttleworth

Head of Quality

Balfour Beatty

Sue Robbins

Audit, BMS & Nuclear
Safety Manager

Balfour Beatty



Hinkley C Marine Works

Tim Shuttleworth and Sue Robbins



Agenda

1. Hinkley C Marine Works Project
2. Balfour Beatty Quality Team
3. Managing Quality on the Project
4. The Interface with NNB
5. Nuclear Safety
6. Questions

Hinkley Point C Marine Works Project

The Project

- Awarded contract and replaced previous contractor in August 2017
- Mobilised in September 2017
- Took over existing facilities at Hinkley Point C & Avonmouth in December 2017
- Segment factory production has started
- Tunnelling started 2018

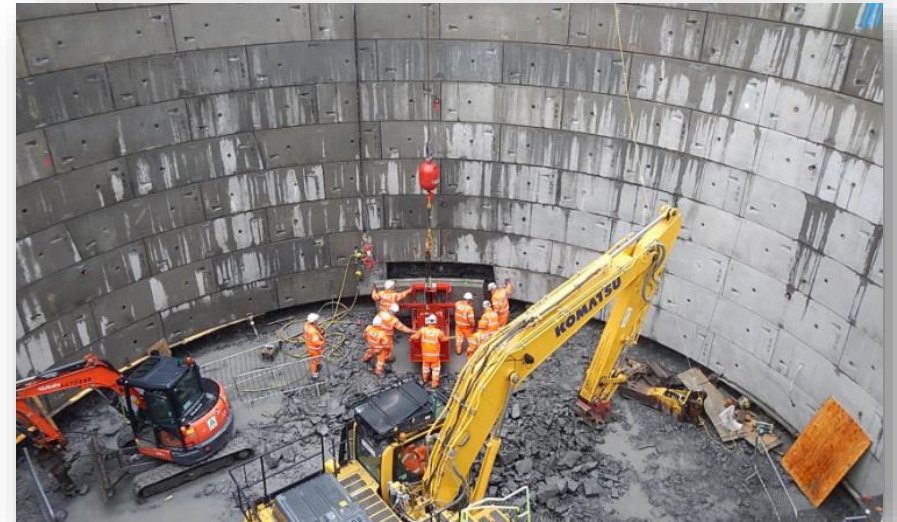

The Project

The scope of the project involves:-

- Hinkley C Heat Sink – Cooling water system.
- Driving of 2No. cooling water intake tunnels x diameter 3.3km long
- Driving of 1No. cooling water outlet tunnel x diameter x 1.8km long
- Onshore galleries and connecting tunnels & associated shafts
- Construction of 4No. intake heads (circa 5000t) and 2No. outfall heads (circa 3000t)
- Construct and operate precast tunnel segment factory at Avonmouth to construct near 40,000 tunnel segments
- Offshore marine works to place the 6 heads and connect tunnels via shafts

Progress 40,000 segments for tunnels



Offshore Heads

Intake heads x 4

- 44m long, 17m wide and 8m high
- Circa 5000 tonnes

Outfall heads x 2

- 16m long, 16m wide and 8.6m high
- Circa 3000 tonnes

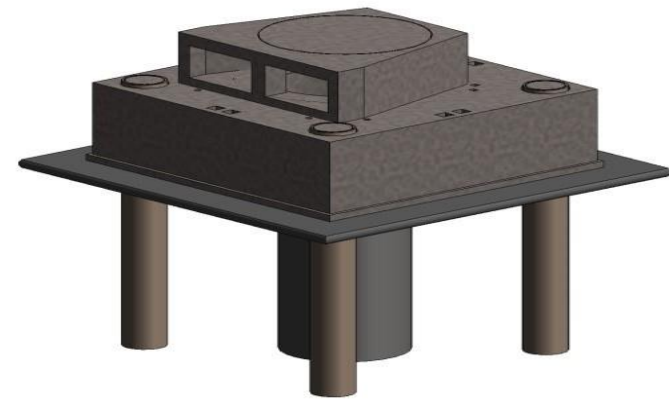
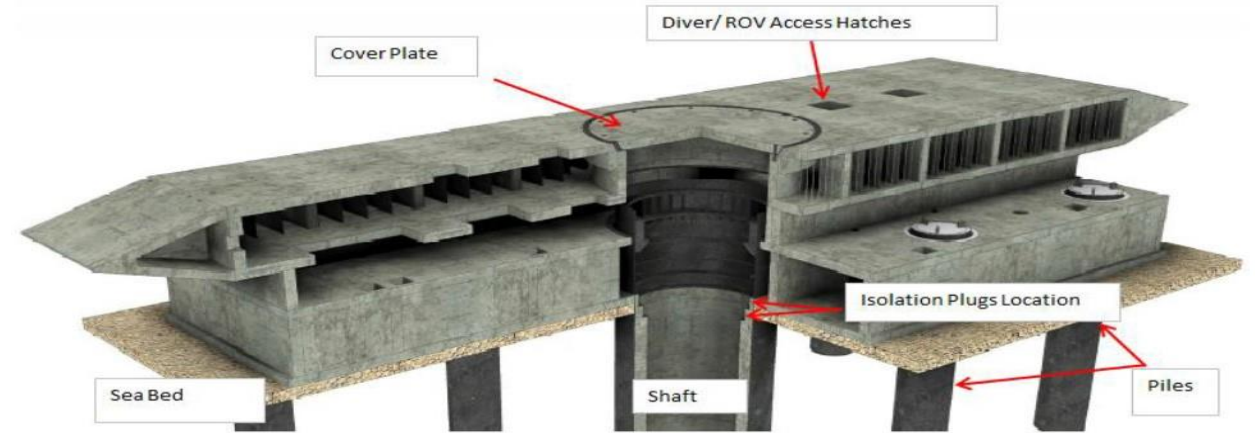

Intake / Outfall Tunnel Details

- Driven by Tunnel Boring Machines (TBM) with a pre-cast concrete segmental lining
- Intake 3.3km long, 6 m internal diameter
- Outfall 1.8km long, 7 m internal diameter

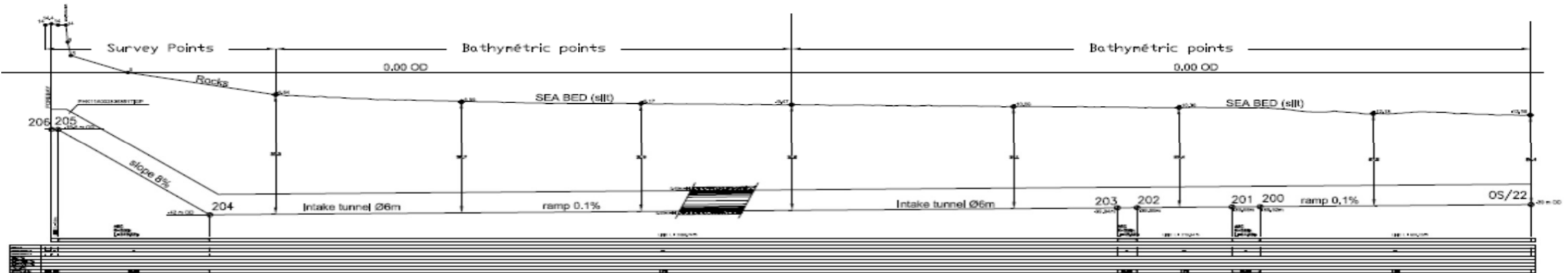
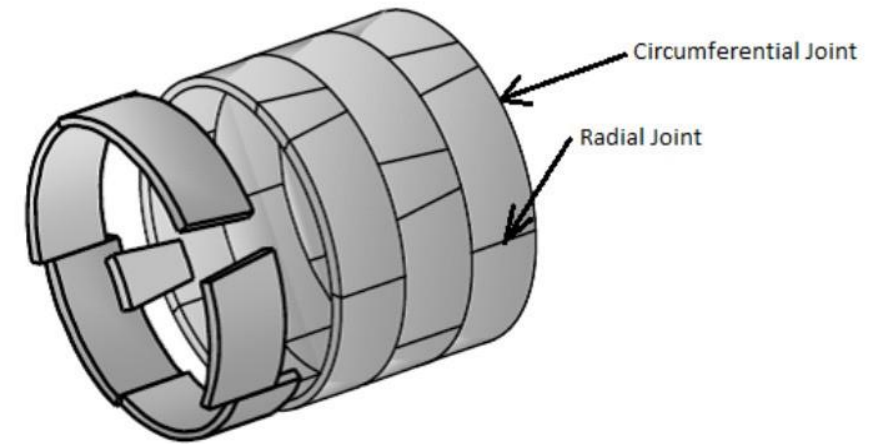

Balfour Beatty Quality Team

The Quality Team

Quality Team Organisation Chart

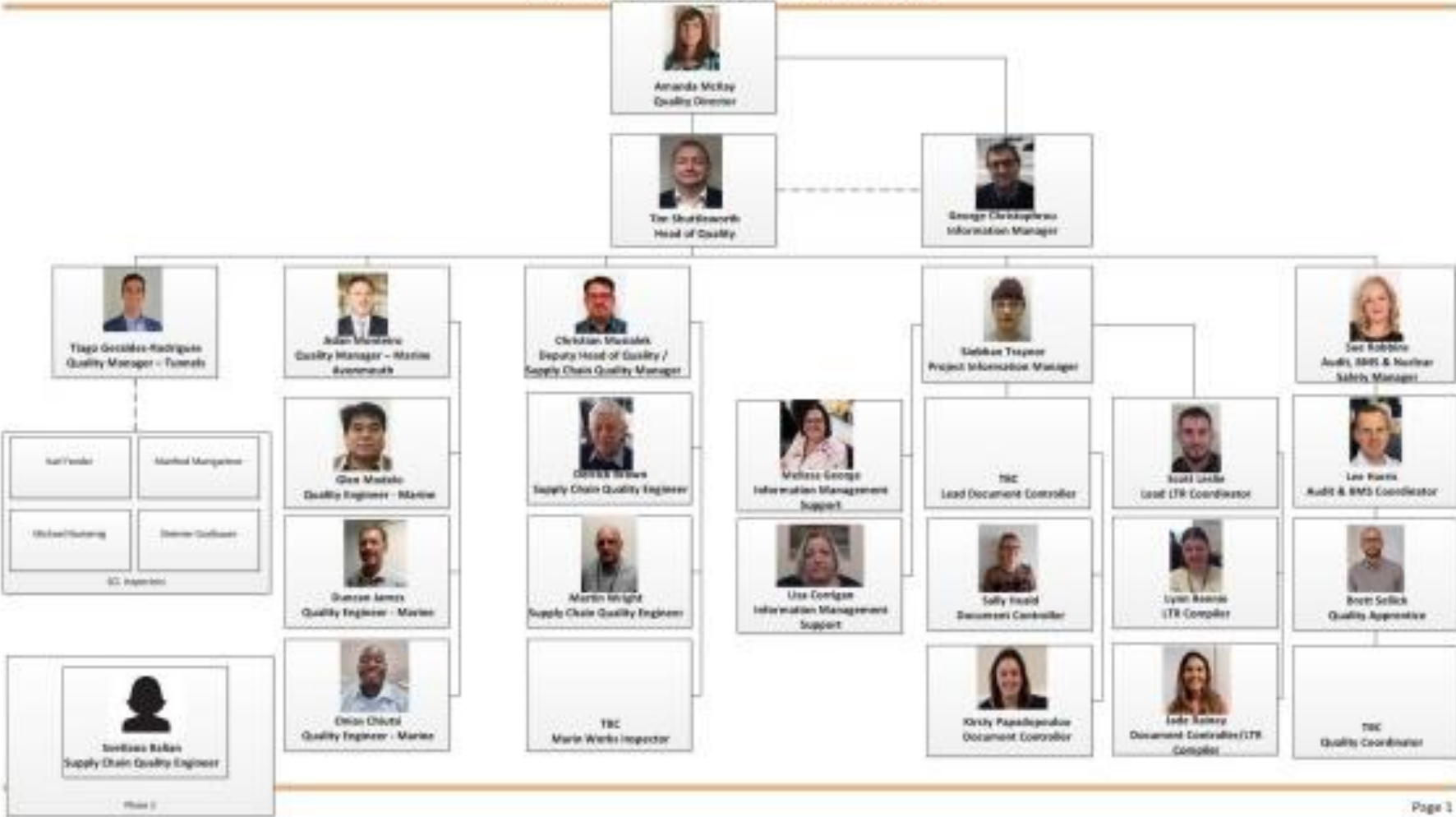

The Quality Team

- Structured to support the project
- Challenging environment
- Team embedding nuclear safety culture within the project team and supply chain.
- Ensuring compliance to all regulatory, legal and client requirements
- Team selected from many industries to support the needs of the project such as :-
 - Nuclear, tunnelling, highways, rail, oil and gas

Managing Quality on the Project

What does quality look like in the nuclear industry?

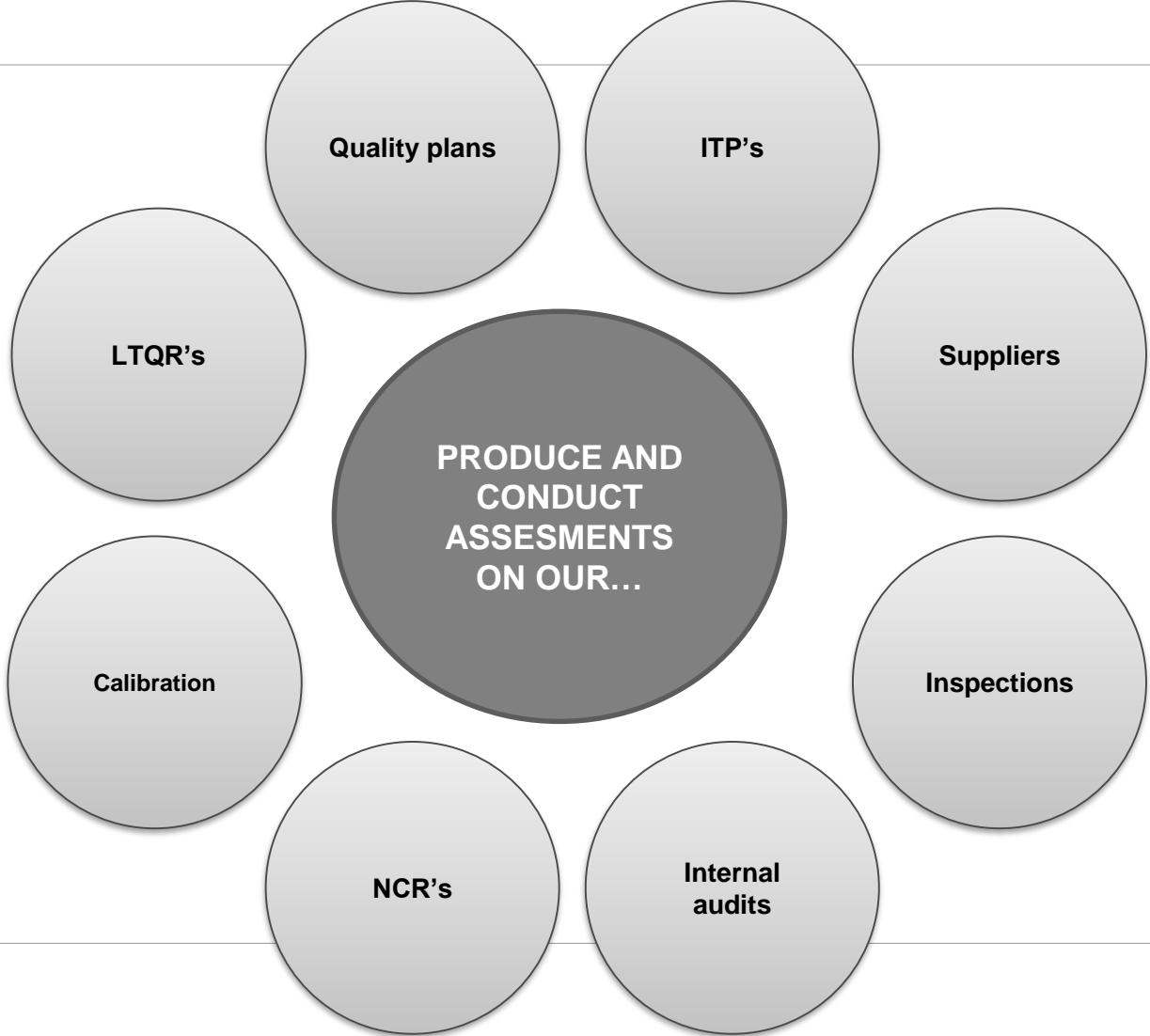

Quality Related Activities

QRA's are inspection points where an additional inspection is required if the following questions result in a 'Yes' answer

Is there a likelihood that an error occurring during the activity may remain undetected by a downstream activity?

and

Does the failure of the activity have the potential to impact Nuclear Safety?

Over 80,000 QRAs on this project

The Interface with our Client, EDF Energy

Client Interface

Daily interface with the Client, EDF Energy

Client has 5 inspection teams

- Responsible Designer
- Site surveillance team
- Off site manufacturing
- Delivery group (construction)
- QA team

Nuclear Safety

Nuclear Safety Culture

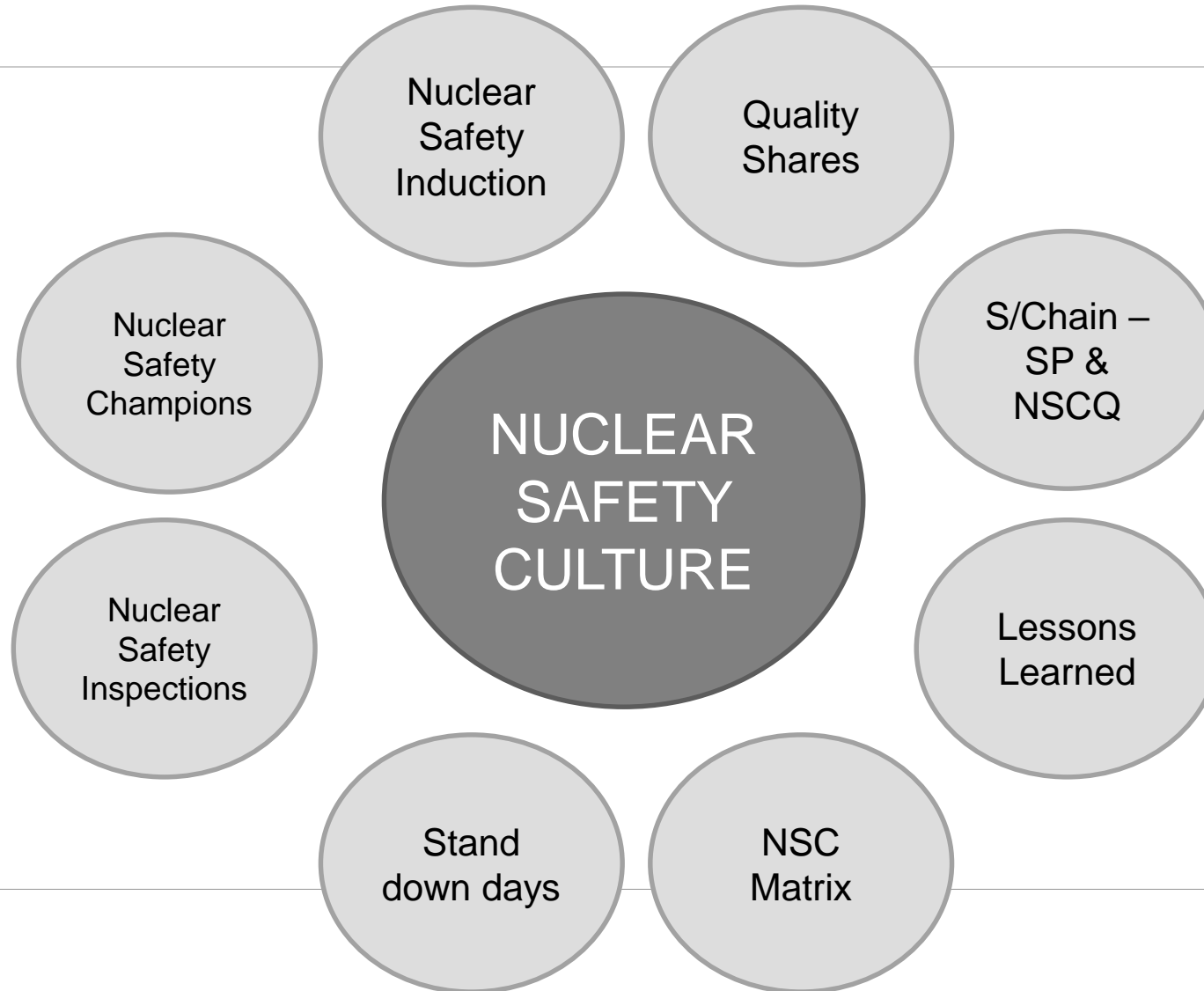

“Best in class”

Nuclear Safety Inductions

ONR

IAEA
International Atomic Energy Agency

Office for Nuclear Regulation
Licence condition handbook
February 2017

Defence Level 1 Organisational Processes
IAEA INSAG 10 Defence in Depth

Design process, Procurement, Construction Practices, Specification, Training

"QUALITY IS NOT AN ACT, IT IS A HABIT"

Hinkley C Marine Works
Module 5 – Nuclear Safety Culture

This certificate is presented to
Joe Bloggs
For successfully completing Module 5
On 1st January 2019



CERTIFIED ISO 9001 CERTIFIED

Balfour Beatty
NUCLEAR SAFETY INDUCTED

Over 1000 people inducted in last 12 Months

Nuclear Safety Champions Forum

20 Members
of the forum

Your Pathway to Becoming A Nuclear Safety Champion

Name:

Description	Date Completed	Confirmed By:	Signature:
Attend Module 5			
ERT Part 1			
ERT Part 2			
SLC Presentation 1			
SLC Presentation 2			
SLC Presentation 3			
SLC Presentation 4			
NIA Presentation			
Present Module 5			
Deliver ERT Part 2			



April – Chernobyl Stand down days



May – HPC Site Tour



June – HPB Tour

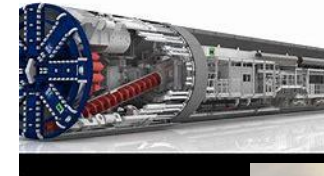

July – TBM Tour



August – Avonmouth Site Tour

Nuclear Safety – Supply Chain



All suppliers receive TBT

Balfour Beatty

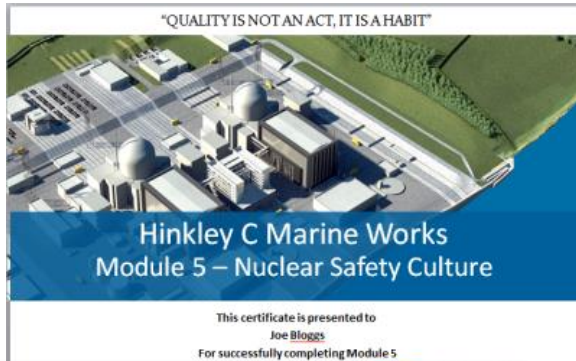

Nuclear Safety Inductions

ity

SURVEILLANCE PLAN RECORD FORM Balfour Beatty

Document Number: HPC-OH2231-IBB-RA-FRM-GEN-

Criticality Assessment	QAS Applicable Yr	GGAS Grade:	Package Number	Package Description	
ASSESSMENT GRADE REQUIREMENTS					
ACTIVITY	ASSESSMENT GRADE A	ASSESSMENT GRADE B	ASSESSMENT GRADE C	ASSESSMENT GRADE D	SPECIFIC REQUIREMENTS
• GGAS Verification	As required based on GGAS OA Grade	As required based on GGAS OA Grade	As required based on GGAS OA Grade	As required based on GGAS OA Grade	
• Quality Related Activity Assessment	As required based on GGAS OA Grade	As required based on GGAS OA Grade	As required based on GGAS OA Grade	As required based on GGAS OA Grade	

All packages assessed for surveillance requirements

CONTRACTOR DOCUMENT FRONT SHEET Balfour Beatty

NOT PROTECTIVELY MARKED

DOCUMENT DETAILS																								
PROJECT	CONTRACT CODE					ASSET ZONE	SYSTEM BUILDING			DOCUMENT TYPE	SEQUENTIAL NUMBER													
H P C -	O	H	2	2	3	1	-	X	X	-	0	0	0	-	F	R	M	-	1	0	0	0	0	3
DOCUMENT TITLE		Nuclear Safety Culture Questionnaire										EMPLOYER REVISION		03										
DOCUMENT		DOCUMENT PURPOSE		S2 - FIT FOR INFORMATION					TOTAL PAGES (including this page)		18													

NSCQ

Questions



Balfour Beatty



NucSIG & ConSIG Collaboration

Mike Buss

Head of Quality

Taylor Woodrow

Alan Grogan

Head of Quality

Nuvia



NucSIG/ConSIG Collaboration

Mike Buss – Head of Quality – Taylor Woodrow
(Vinci Construction)

ConSIG (Competency Working Group Chair)

Alan Grogan – Head of Quality – Nuvia (Vinci
Construction)

NucSIG (Steering Committee Member)



- HOME
- KNOWHOW
- EVENTS
- WORKING GROUPS
- TRAINING
- USEFUL LINKS
- ABOUT CONSIG
- SUGGESTIONS
- LINKEDIN

ConSIG Website

- KnowHow
- Events
- Working Groups
- Training
- Useful Links
- About ConSIG
- Suggestions
- Linked-in & Twitter



Click to find out more >

Simple, practical and useful information for day to day management of construction quality



Construction SIG @ConSIGCQI

Tweets by @ConSIGCQI

CQIConSIG
@ConSIGCQI

Our Chairman Jon Adshead leading tonight's Q&A
[#ConSIGEFQM](#)

NucSIG Website



- Steering Group information
- Nuclear Skills & Competency
- Standards & Guidance
- Events
- Nuclear Links

This is the website of the Chartered Quality Institute's Nuclear Special Interest Group (NucSIG). NucSIG was set up by volunteer members in 2007 to provide an opportunity for networking and sharing of best practice amongst quality professionals in the nuclear sector or who are considering working in the sector.

We aim to encourage membership of CQI amongst Nuclear Quality Professionals. We

Why should we not collaborate?

- Quality professionals are different in our industry?
- We use different tools to you?
- We run projects completely differently?
- Our problems are different to yours?
- We have nothing to learn from you?



specific attention is given to identifying the root cause.

The 5 Whys is a very simple but effective way to help determine the root cause of an issue by continually asking 'why' until the root cause is identified.

What is 5 Whys?

It is not unusual for young children to ask 'why' when discussing something. Having been given an answer for the adult, the young child then asks 'why' again but this time in relation to the answer given, the adult answers and the child persists asking why again in relation to the next answer and so on. This can be very annoying! However, the child is actually demonstrating the principle of the '5 Whys' very effectively. The child (perhaps unknowingly) is trying to find the basis of the reason for the adult's decision.

The '5 whys' quality tool is simply a way to delve deeper and deeper into the reasons for what has happened. Each time a question is asked and answered we can refer to this as a 'level'. When no further answers can be given, theoretically, the 'root cause' has been determined.

It is often assumed that asking 'why' 5 times allows the root cause to be identified (although this may not always be the case).

	Question	Answer
Level 1	Why was the bolt not tightened to the correct torque?	The operative was not aware that the bolt had to be tightened to a specified torque.
Level 2	Why was the operative not aware that the bolt had to be tightened?	The operative did not receive information from the supervisor.
Level 3	Why did the supervisor not supply information to the operative?	The supervisor did not have the information available.
Level 4	Why did the supervisor not have the information available?	The supervisor could not access the network drive system.
Level 5 (root cause)	Why could the supervisor not access the network drive system?	There was no power due to electrical testing.

It is important to recognise that an issue may initially appear to be the result of one thing when in fact the root cause is completely different. It is this root cause that will enable the problem to be

Step 1 - Quality Tool Share

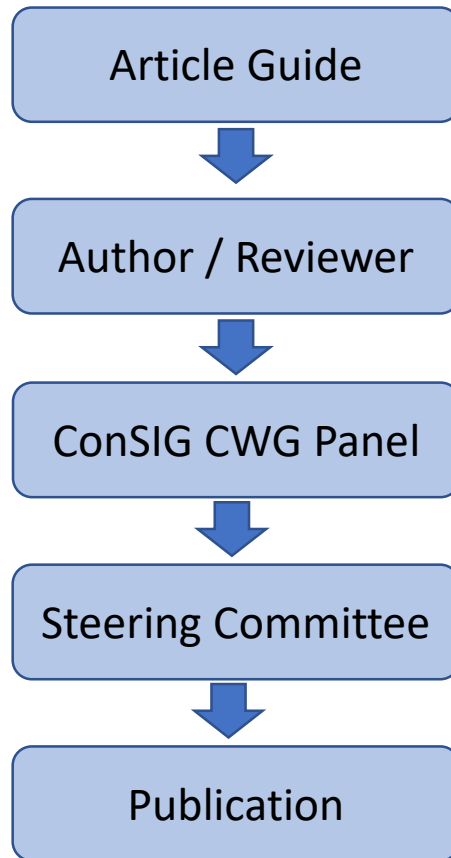

- Concern – CQI Knowledge webpage
- Shared page between two sites
- Simple two sided A4
- Authors & Reviewers
 - ConSIG membership - 1400
 - NucSIG membership - 1045
- Quality Apprentices... as authors?

Step 2 – Shared Events



Slido Poll

Future NucSIG event



Project Quality in Oil & Gas

Giorgio Mannelli

Project Quality Lead

Nuvia



What is important about Project Quality in the Oil&Gas?

Nuvia Project Quality Lead
G.Mannelli CQP MCQI - MAPM

Index



Definition of
“Oil&Gas”



Viewpoint for this
presentation



Differences
between Nuclear
and Oil&Gas



Similarities
between Nuclear
and Oil&Gas



Basics for the
success in Project
Quality



Adventures in the
Oil&Gas

What is "Oil&Gas"?

Considered to be the biggest sector in the world in terms of dollar value (www.oilandgasiq.com)

There are specifications for over 2000 individual refinery products (Colorado School of Mines)

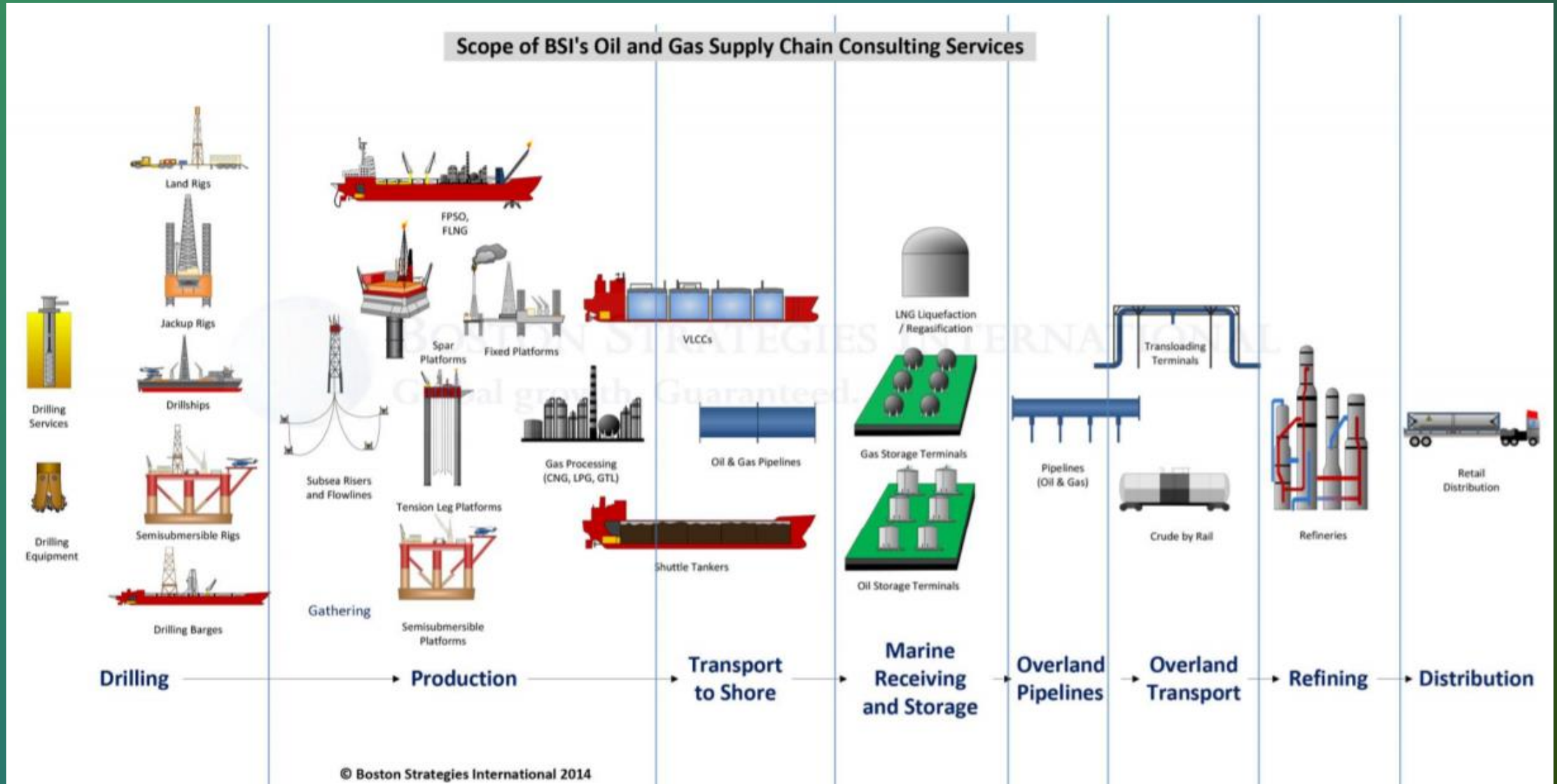

■ Upstream

- Drilling
- Production

■ Midstream

- Transportation
- Treatment

■ Downstream

- Industrial
- Residential
- Commercial

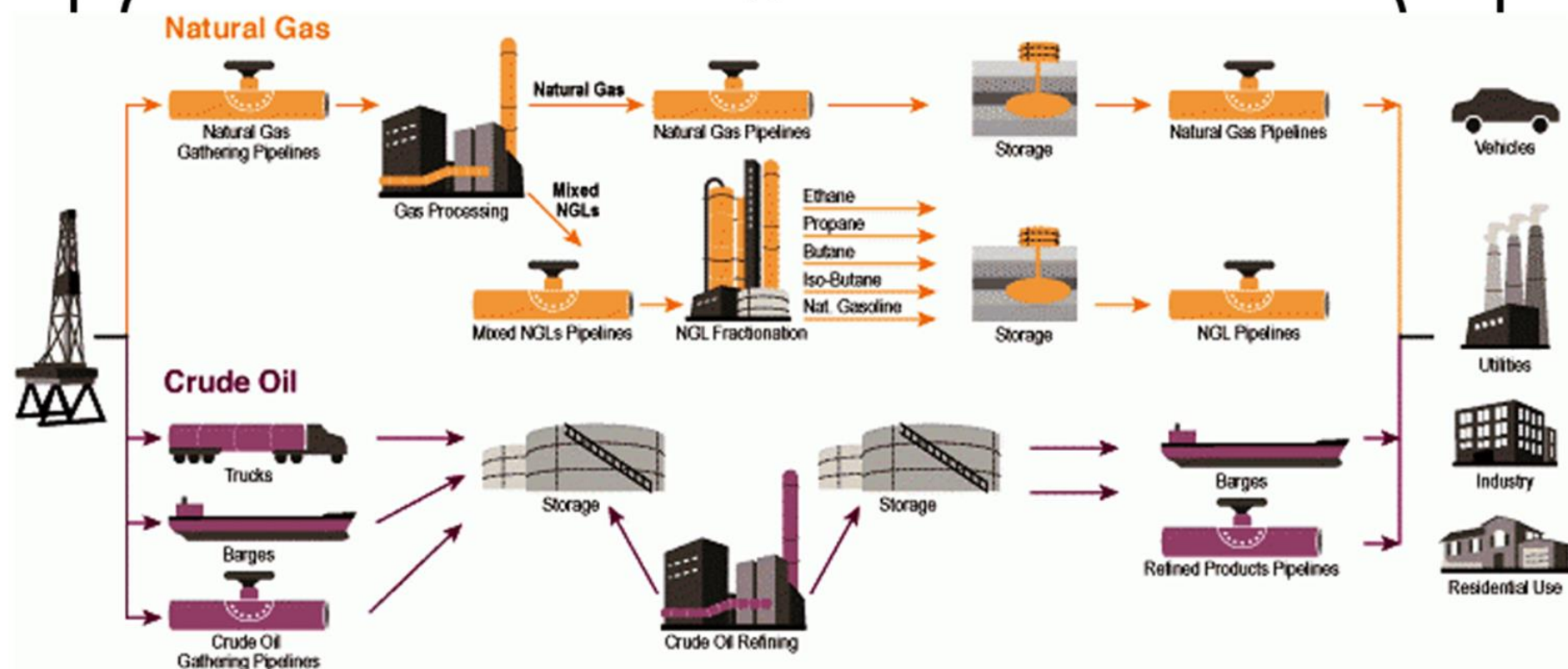

Viewpoint of this presentation



A high level overview of the main elements to be considered when dealing with Quality in an Oil&Gas project.



The focus is on the execution of works by first tier contractors and does not include the specific Quality Management System of the upstream / midstream / downstream operators.



As per any project, customisation greatly depends on the project scope, the client, the country, and the various stakeholders.

Similarities between Nuclear and Oil&Gas



INTERNATIONAL
AND NATIONAL
STANDARDS

seldom difficult to
get and to check if
applicable to the
scope of work



LONG TERM
ACTIVITY



HIGHLY
DETAILED
CONTRACTS



COMPLEX
SUPPLY CHAIN



INTERNATIONAL
PLAYERS AT ANY
LEVEL

ADVANCED QMS

Differences between Oil&Gas and Nuclear

QMS in Nuclear

“Westinghouse QMS may be submitted to a governing regulatory agency....Westinghouse **submits the QMS to the NRC** for review and acceptance prior to implementation of **any changes that reduce commitments contained herein for safety-related items and services** subject to 10CFR50, Appendix B, **ASME NQA-1**, or applicable NRC Regulation Guides. Westinghouse informs the NRC within ninety days of any implemented QMS changes that do not reduce QMS commitments in accordance with 10CFR 50.4 requirements.”

Westinghouse Quality Management System-
A, 2013

QMS in Oil&Gas

- QMS not subject to regulatory agency approval.
- Changes to the QMS are not considered impacting Safety, that is managed as a stand alone discipline, without direct influences from Quality.
- QMS is ruled by a voluntary standard, ISO29001 "Petroleum, petrochemical and natural gas industries - Sector-specific quality management systems - Requirements for product and service supply organizations".

Differences between Nuclear and Oil and Gas

Nuclear

- Governments agencies highly involved
- Longer duration for a nuclear plant, hence higher opportunities to have multiple contracts
- Higher number of contractors due the peculiarities of some items to be supplied
- “Suitably Qualified Experienced Persons”
- Security Clearance
- Higher reliance on Client’s requirements/systems
- Test for materials in radioactive operation conditions
- Quality Related Activities
- Life-Term Quality Records
- Virtually unlimited funds

Oil and Gas

- ▶ Usually single Government / Agency involved (except cross countries pipelines)
- ▶ Shorter duration
- ▶ Different dominant influences about practices (i.e. criticality rating not always used)
- ▶ Harmonization along carbon value chain still ongoing
- ▶ Huge budgets but self-funded by the oil companies

Basics for the success in Project Quality

The critical point is to have a good Governance, that involves Quality since the start of the Project.

Essential elements of the Governance are:

- ▶ Policy
- ▶ Objectives
- ▶ Management Plans
- ▶ Organisation of Resources with clear Roles & Responsibilities
- ▶ Coordination of the activities
- ▶ Control of Design Changes
- ▶ Suppliers / Sub-contractors selection
- ▶ Monitoring
- ▶ Inspection (including counterfeit material and work ethics)
- ▶ Stakeholders interface (client, notified bodies, Authorities, suppliers, sub-contractors, local communities, et al.)

Main deliverables and procedures where Quality should be involved

Engineering level

- Deliverables list
- Project Schedule – level 1, 2, 3
- Project “plans”:
 - Project Management Plan
 - Project Control Plan
 - Project Engineering Plan
 - Procurement Plan (including inspection and expediting)
 - Sub-contracting Plan
 - Project Quality Plan for both assurance and control
 - Interface Management Plan
- Notified and/or regulatory bodies
- Audit schedule
- Non-conformity procedure including internal and external non-conformities
- Distribution matrix
- Monthly reports (QUA section)

Procurement

- Supplier quality requirements (QUA Inputs)
- Suppliers Pre-qualification and selection (QUA involvement)
- Supplier Document List
- Inspections schedule (Procurement Inspectors Coordinator)
- ITPs (from Procurement inspectors)
- Inspection reports (managed by Procurement inspectors and shared with QUA)
- KoM with suppliers (QUA involvement)

Construction

- Sub-contractors Quality Plan
- Sub-contractors ITPs
- Test-packs (i.e. pressure tests)
- Punch lists

Phases of an Oil&Gas project and involvement of Quality

▶ Tendering phase

Short time; intensive effort; direct involvement limited to:

- Project quality plan in draft, customised as per client quality specification;
- Support to other disciplines to identify risks and mitigation.

▶ Front End Engineering Design

Short time; part-time involvement mainly for audits and issuing Pr. Quality Plan.

▶ Preliminary Design

Medium-long term (3,5 - 4 years)

▶ Detail Design

High number of team members (200 or more)

▶ Procurement

Multiple office configuration

▶ Construction

Joint ventures

▶ Pre-commissioning

High number of sub-contractors and suppliers

▶ Commissioning

Overcomplicated supply chain, with suppliers and sub-suppliers from any part of the world.

Countries in the black list from the client or the government of the client.

Multiple stakeholders at site: public officials, client representatives, plant operator, client's of the plant operator.

PROJECT PLANS

Design & Procurement

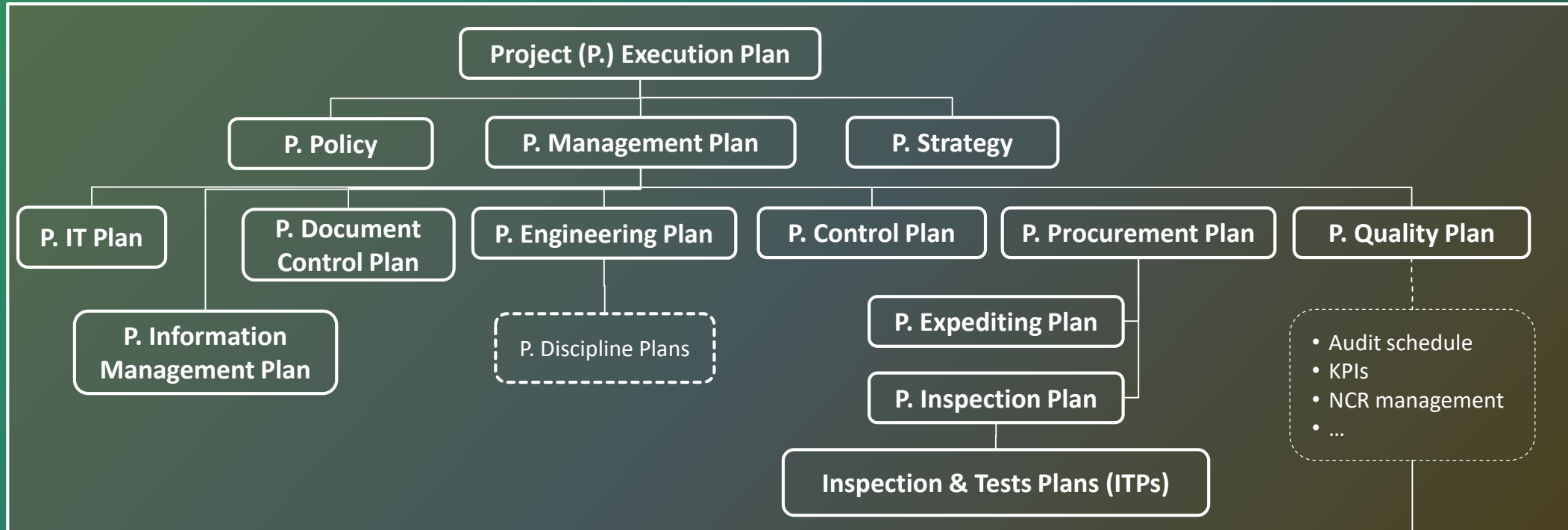

Construction

Pre-Commissioning

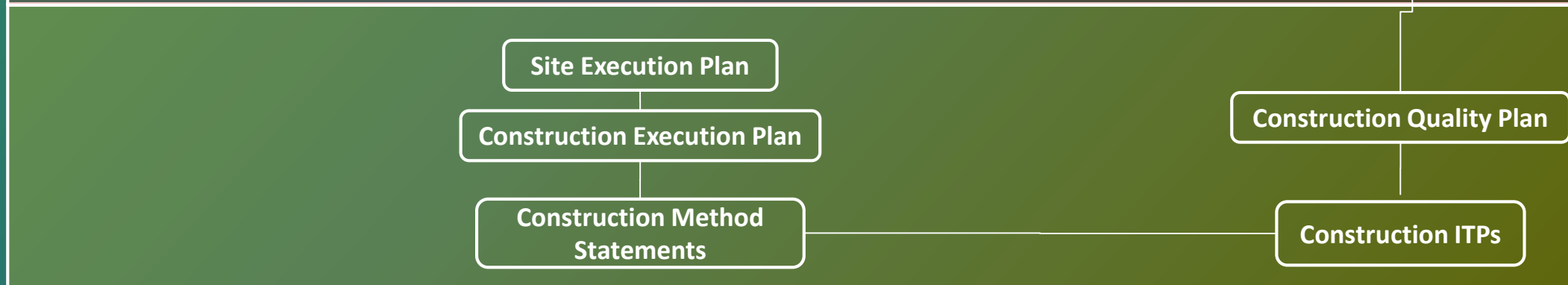

Commissioning



Organisation chart

Design & Procurement



Construction

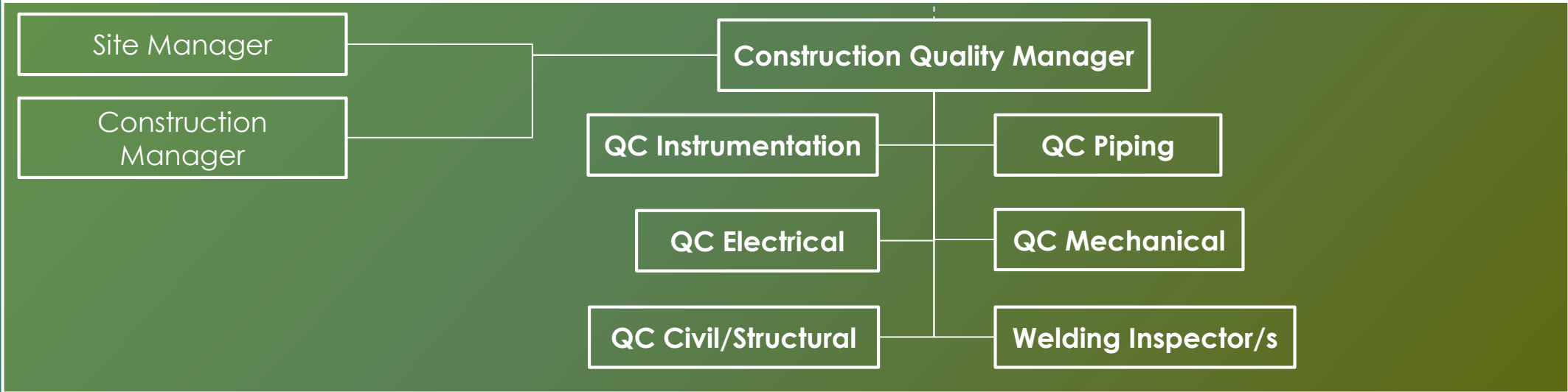

Pre-commissioning

Commissioning



“Adventures” in the Oil&Gas

Greenfield

Brownfield

Archaeological investigation



Roman Villa – Basilicata, Italy

Extension of the plant



Petrochemical plant – Gela, Italy

Authorization from land owners



Multilevel and open to sky



Oil centre– Basilicata, Italy

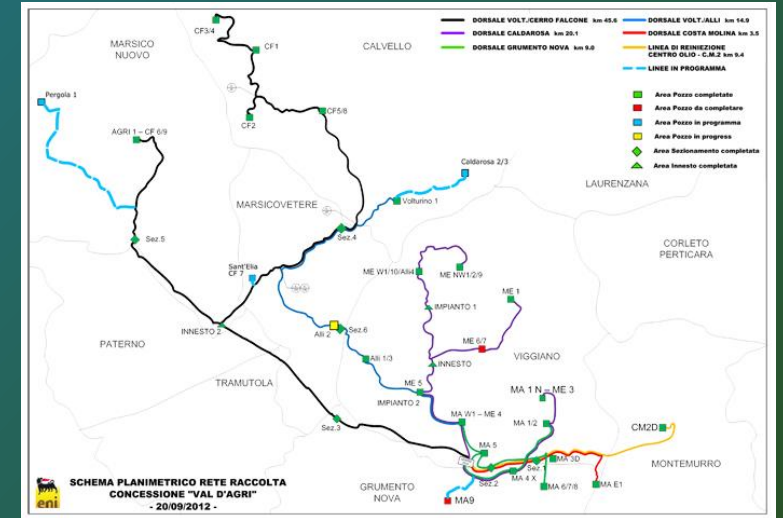

Oil wells network – Basilicata, Italy

Evacuation plan (i.e. war zones, off-shore platforms)

Pre-construction activities (i.e. barracks)

Underground works (i.e. drilling under road)

COFFEE BREAK

Supply Chain Alliance & CFSI

Martin George

Head of Supply Chain
Quality

Sellafield



Counterfeit, Fraudulent and Suspect Items (CFSI)

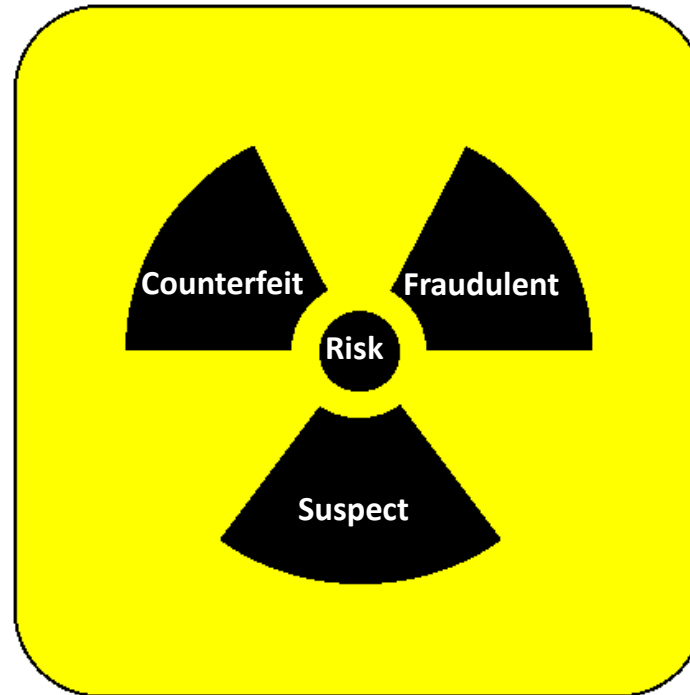

A RISK NOT WORTH TAKING

Introduction

The aim of this presentation is to provide guidance on the aspects of preventing, detecting and responding to the threat of counterfeit product / service supply within Nuclear Licensed facilities

So what is CFSI?

- CFSI items are being discovered all over the world, in all industries and walks of life
- The use of substandard, non-conforming parts or equipment can affect processes, operations and safety
- Mitigating the risks of CFSI entering processes within Nuclear facilities is a focus area for UK Nuclear Licensees, the Office for Nuclear Regulation (ONR) and the Nuclear Industry supply chain

Iceberg Effect

**Handbags
Watches
CDs
Sunglasses**

**Clothing
Money
Cigarettes**

**Straighteners
Horsemeat
Appliances**

**Pacemakers
I-Phones
Phone Chargers**

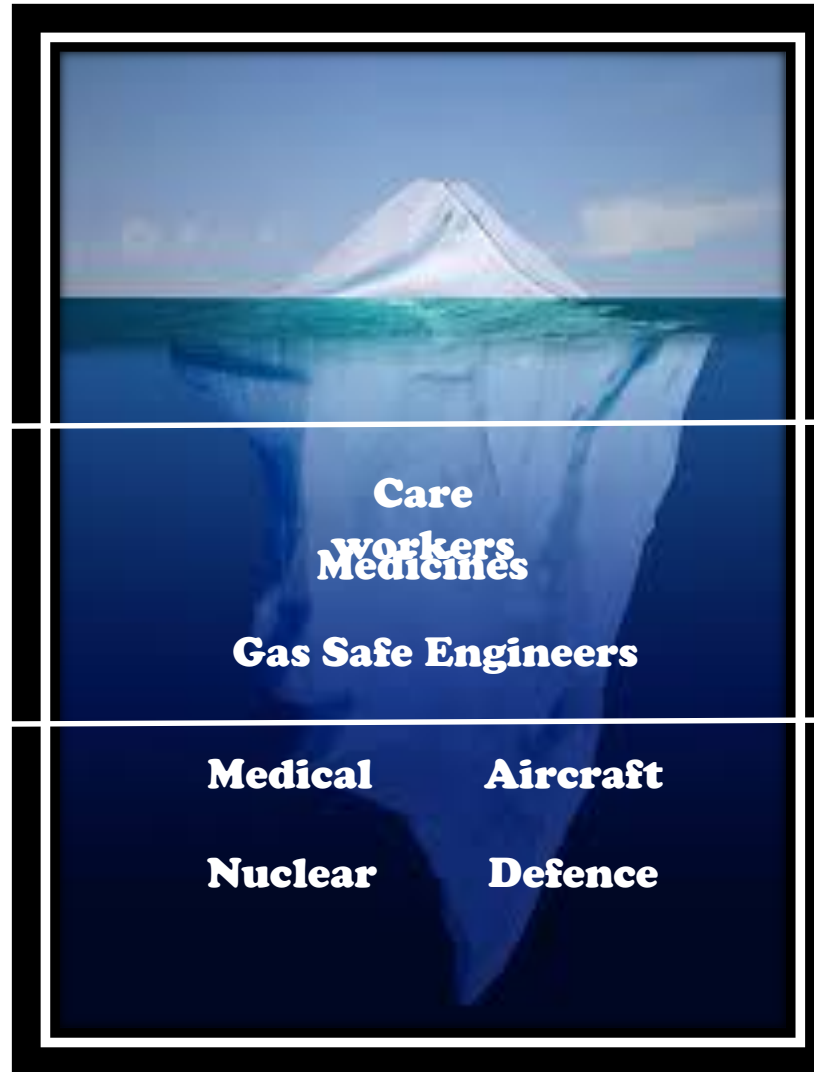

Consequences

<u>No Personal Risk</u> Watches (Rolex) T-Shirts (Nike/Adidas/Football etc.) Media (CDs, DVDs etc)	<u>Unseen</u> Child Exploitation Terrorism
<u>Potential Personal Risk</u> Alcohol Sunglasses Medicine	Cosmetics Care Services Horsemeat
<u>Risk to Community</u> Cars and Components Domestic Appliances	Cyber-Attack Building Materials
<u>Risk to Industry and Society</u> Nuclear Industry cannot accept such risks and needs to have assurance built into procurement processes	

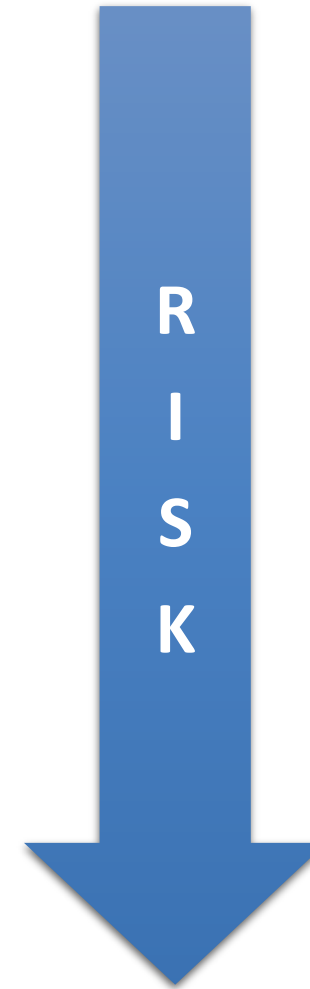

SLM 4.06.02: SL Contract Quality Requirements

One of a series of documents within SL Management System. It defines the Contract Quality Requirements that will enable delivery of products and services with the appropriate Oversight & Assurance arrangements (Quality Grade)

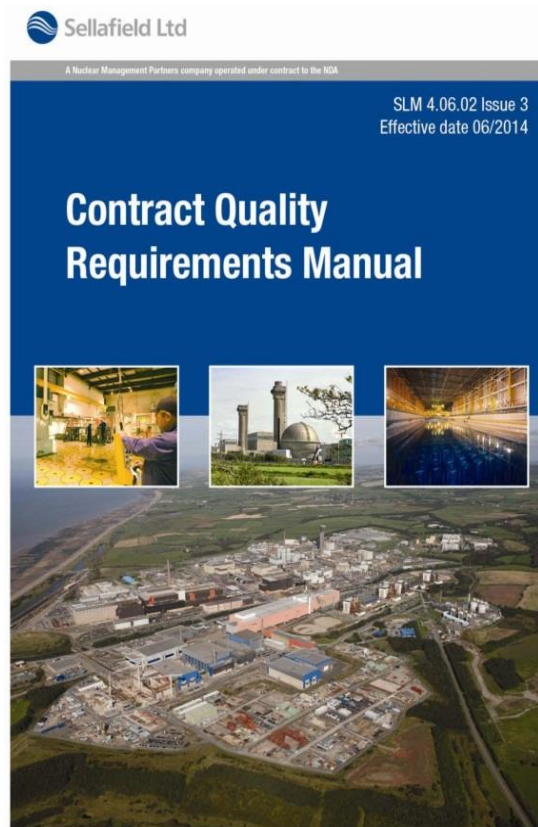

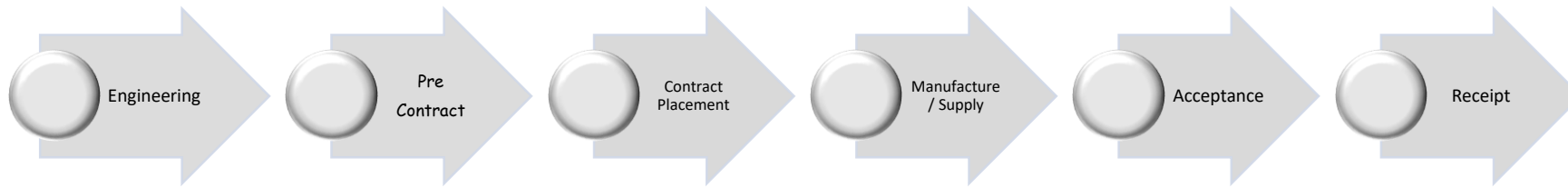

Awareness



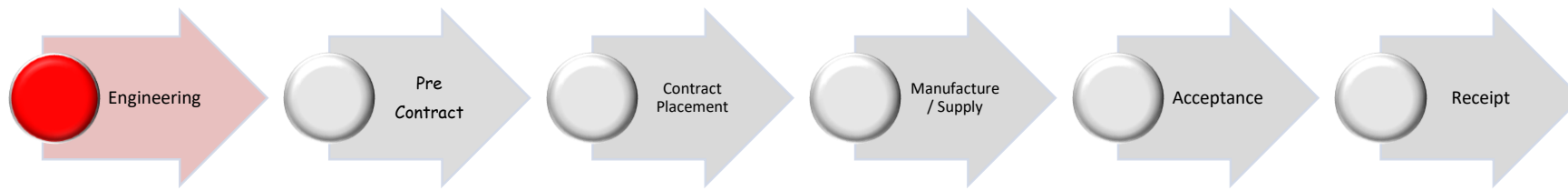

Awareness

How can I mitigate the risk of CFSI in the Engineering stage?



- ✓ Technical specification
 - ✓ Acceptance criteria
- ✓ Fit for Purpose Engineering
- ✓ Obsolescence Management



Consider the lifecycle of the product or service

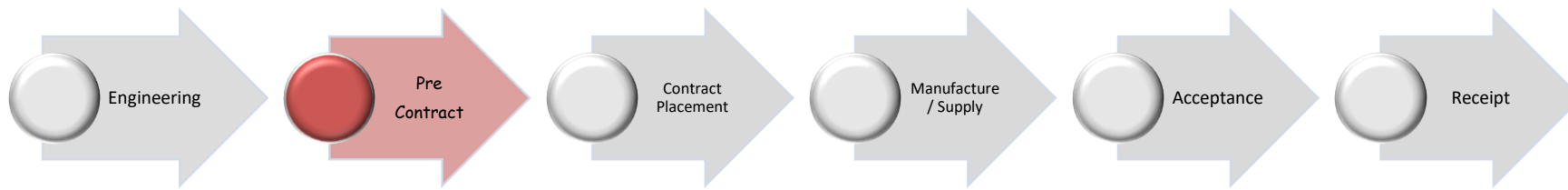

Awareness

Do suppliers understand the risk of CFSI?



- ✓ Make your requirements clear
- ✓ Robust Supplier selection process
- ✓ Understand your Supply Chain
- ✓ Confirm the suppliers arrangements
- ✓ Promote awareness of CFSI with your suppliers



Consider early engagement with supply chain at design stage

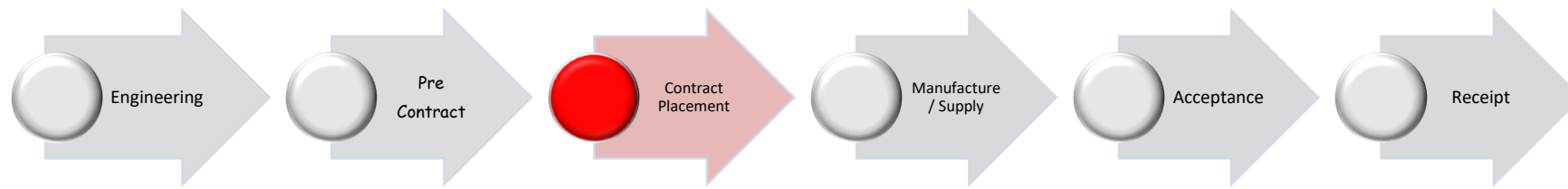

Awareness

Do suppliers understand the contractual requirements?



- ✓ Flow down of requirements
- ✓ Supplier oversight and assurance
- ✓ Performance monitoring
- ✓ Traceability throughout the product or service lifecycle



Demonstrate that the risk of CFSI is understood throughout the supply chain.

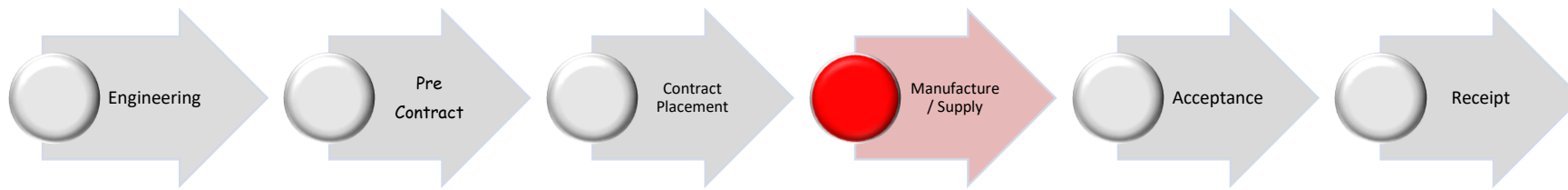

Awareness



- ✓ Compliance with Quality Plans and Inspection & Test Plans
- ✓ Non-conformance management
- ✓ Verification of activities



Do not allow CFSI to re-enter into the Supply Chain

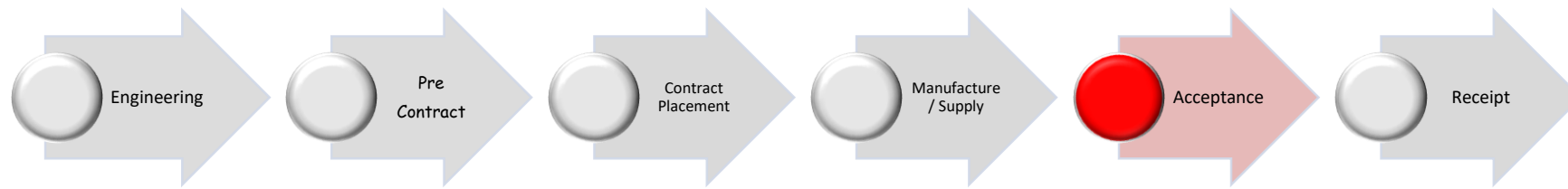

Awareness



- ✓ Works Testing, Factory Acceptance Test.
- ✓ Verify Records, Certification and documents



Pay attention to documentation and packaging relating to the product

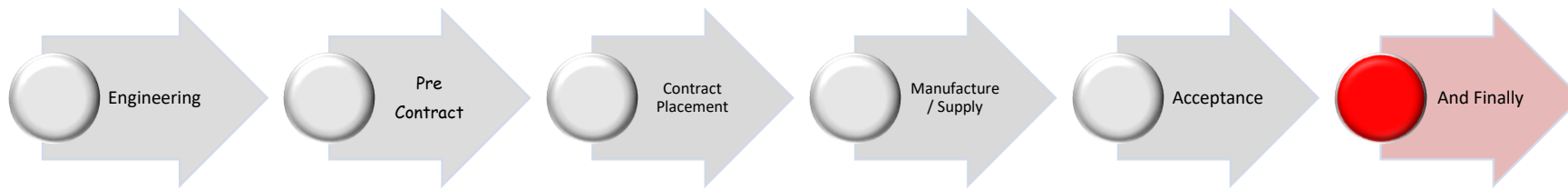

Awareness

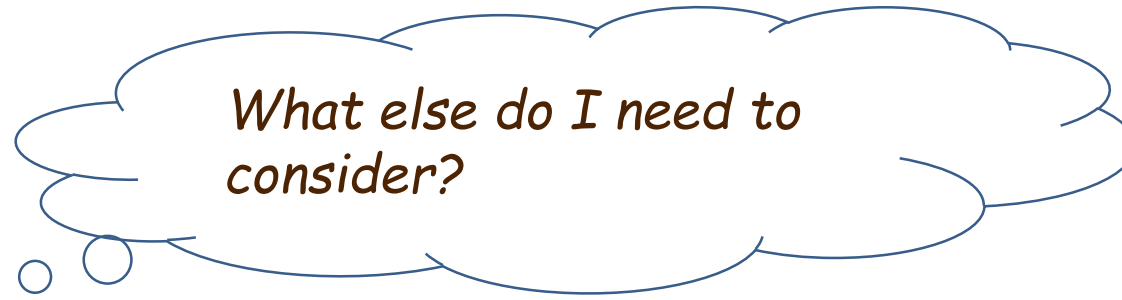

- ✓ Training & Awareness
- ✓ Learning From Experience
- ✓ Reporting



Avoidance of CFSI is everyone's responsibility

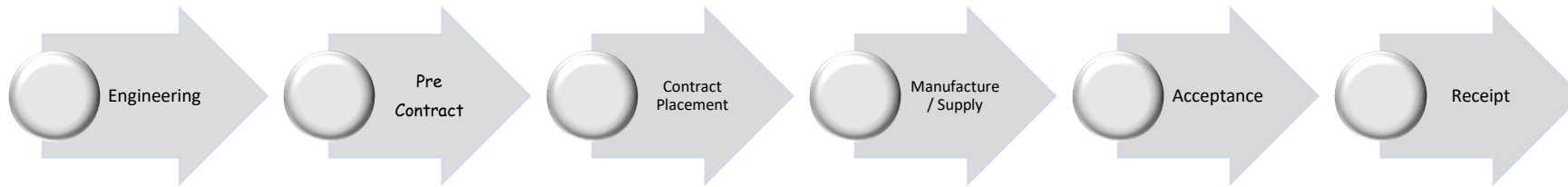

Authenticity



Fake Blackberry Charger

- Sellafield IT Supplier ATOS, have procured Blackberry's not knowing that some chargers are fake
- Injuries have been sustained from fake chargers exploding during charging.
- If you are suspicious that your charger is not genuine –**Do not use it!**

Fake Blackberry Charger

Fake- The logo is larger



Original



Fake Blackberry Charger

Fake

Recess depth is uniform

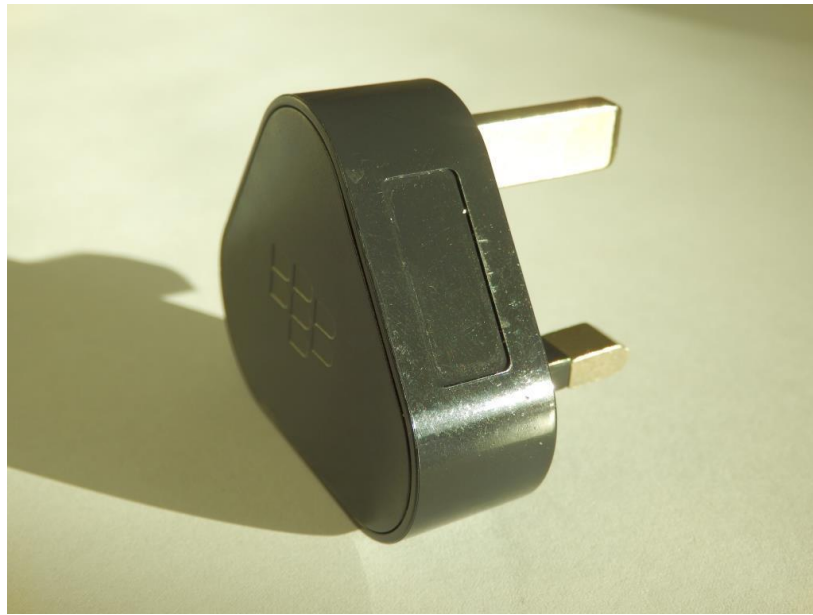

Original

Recess depth is scalloped



Fake Blackberry Charger

Fake- Metal earth pin

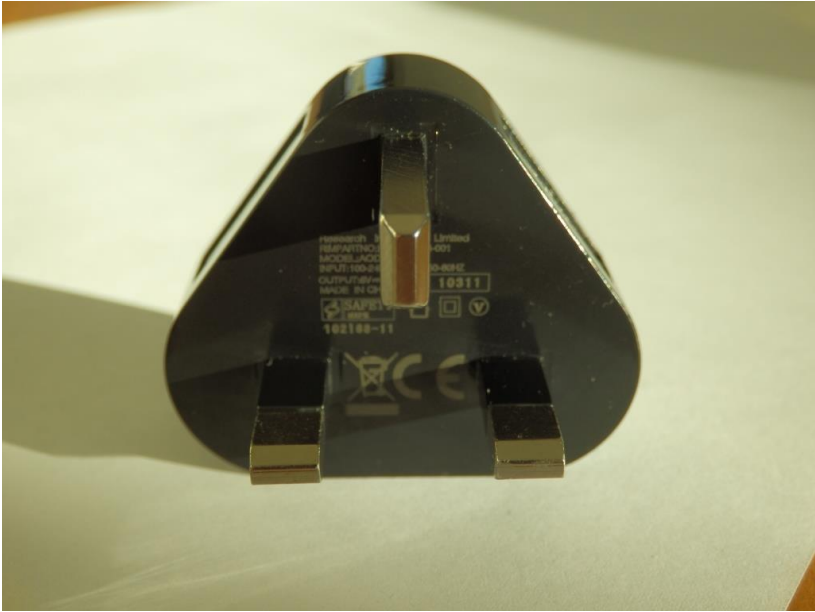

Original- Plastic earth pin

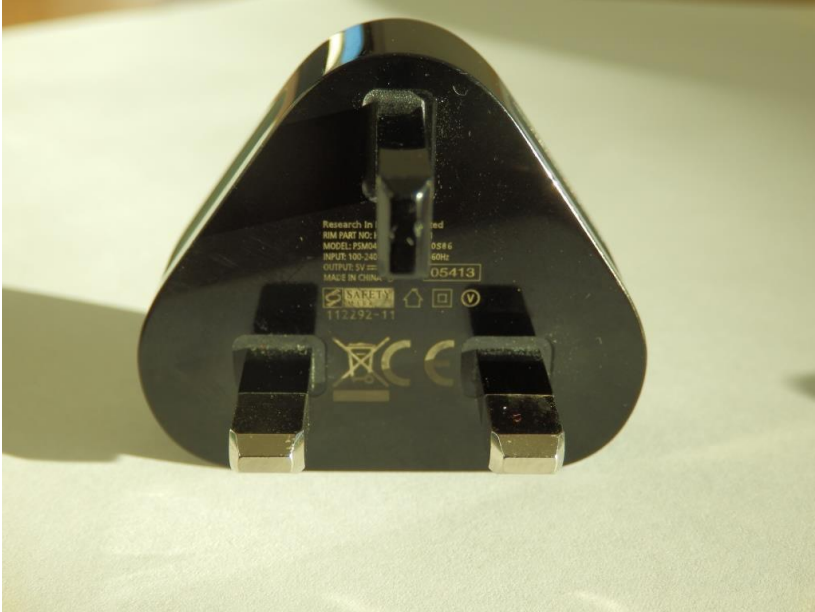

Fake Blackberry Charger

CE Marking looks legitimate but appears more translucent
The Fake is on the left



Safety logo is dark background compared to light on the original.

Fake iPhone Chargers

- Electrical Safety Council - With 64% of fake electrical goods now being sold online – and 44% of MPs surveyed believing counterfeit electrical goods are a problem in their area - Charity's call to cull counterfeiters via digital economy bill

London Fire Brigade - Fake 99p iPhone chargers putting 'lives at risk'

Fake iPhone chargers on sale in the UK could cause fires, electrocutions or burns and are putting lives at risk, warns London Fire Brigade.

The **brigade says that the devices have caused "a number of incidents"** across the capital, including one in February where one caught fire and set alight to a house in Tottenham.

Experts dismantled and tested various counterfeit chargers which are widely available in Britain in markets and online and found that they had around half as many components inside as genuine Apple chargers.

The units made by Apple have around 60 individual parts, many of which are there to prevent dangerous levels of heat building-up, or to prevent electrical shocks. But "sub-standard chargers" had, on average, less than half that number.



The word safety is misspelled "SAEETY" on this plug

Fake 99p iPhone chargers 'putting lives at risk'

Britons buying dangerous counterfeit iPhone chargers for as little as 99p are risking electrocution or burns, warns London Fire Brigade, which says it is 'only a matter of time' before one of them causes a fatal fire

 607   0  9  616  Email



London Fire Brigade has warned people not to use counterfeit chargers Photo: ALAMY

Example of CFSI

PCBs: The left hand PCB is the blacktopped one. Look at the left hand corner how it has been rounded off.



Example of counterfeit items



Which is the counterfeit one of the Square D breakers which entered the supply chain of four US Nuclear Power Plants (NII (NII Op Ex Note 002/08))?

The breaker to the right is counterfeit (post 1999 the ampere rating was printed on the circuit breaker in white).

The counterfeit unit does not have the breaker facility so would not trip when required.

Centrifugal fan drive motor failure



Large Waste Recycling Factory had recently installed some new plant. Photograph supplied by a Sellafield Ltd supplier, who was asked to investigate.

Their comments are below;

“The motor failed after a short period of use. On inspection it was discovered that the connections between the stator cables and the terminal pins have been very hot indeed resulting in the burning back of the cable insulation.

It would appear that the cable lug connection onto the pins has not been capable of carrying the stator current.

This may have been made worse by the ‘Soft Start’ starting as the starting current would be quite high, having said that the motor should have been capable of withstanding the required current without detriment.”

Example of counterfeit items



- Radiography on some pipework being installed identified crack like defects in the carbon steel weld neck flange.
- The flange was replaced.
- Checks discovered that flanges of this cast number had been supplied to SL supply chain.
- Extensive review was carried out of where this cast was used.
- All were found and dealt with.

BE AWARE

- Of shorter lead times than those given elsewhere
- Obsolete items that suddenly become available
- Goods that are much cheaper than expected



If it sounds too good to be true...
...It probably is

Training & Process

Training

developing the skills, experience, a
employees need to perform
improve their performance
skills, and abilities, specific



- ✓ Specific CFSI training & awareness
- ✓ Requirements will differ by role
- ✓ Needed for both your business and your supply chain
- ✓ Robust processes required to avoid CFSI entering your supply chain
- ✓ Enhance your receipt / acceptance processes to detect CFSI
- ✓ Enhance non-conforming process controls - do not allow CFSI to re-enter the supply chain

Summary

- We must all be vigilant to the risk of using CFSI and question anything that appears doubtful, whether employee or supplier
- Ensure that the process of initially selecting and assessing a supplier is robust
- Apply robust monitoring of the supply chain to ensure continuing understanding and compliance with contract and specification requirements
- Never assume that you will always get the correct product/service and the requested certification

Summary – cont.

- If any CFSI items / service are found, suppliers are required to notify their Customer to enable the discovery to be notified to others who may also be using them.
- The items should be quarantined and not returned to the supplier to prevent them re-entering the supply chain.
- We are all involved in ensuring nuclear safety for our Nuclear licensed sites, Stakeholders, Employees and the general public.

A Quality Apprentice`s Perspective

Vic Derbyshire
Quality Apprentice
Nuvia





Introduction of NNG

Howard Cooper
Head of Quality
Jacobs

James Brown
Quality Manager
James Fisher
Secretary NucSIG

Nuclear Next Generation

NNG



Welcome

- Welcome to all from the NucSIG and the NNG
- Thank you to Victoria and Rebecca for the insight and Information on Quality apprenticeships within the Nuclear sector.
- Who am I ... ?
- So, why do NucSIG think Next Generation is so important for the future?

The facts

- From Global Energy Talent Index (GETI) report data from 2018, it was reported that 75% of the sector were 45 and over with only 1% being aged 18 – 24.

AGE

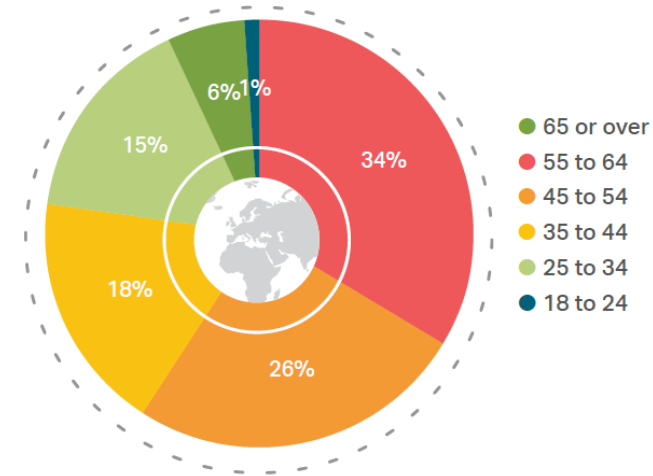

- The 2019 the GETI report data isn't much better with almost 50% being reported to be 45 and over with only 7% being aged 18 – 24.

AGE

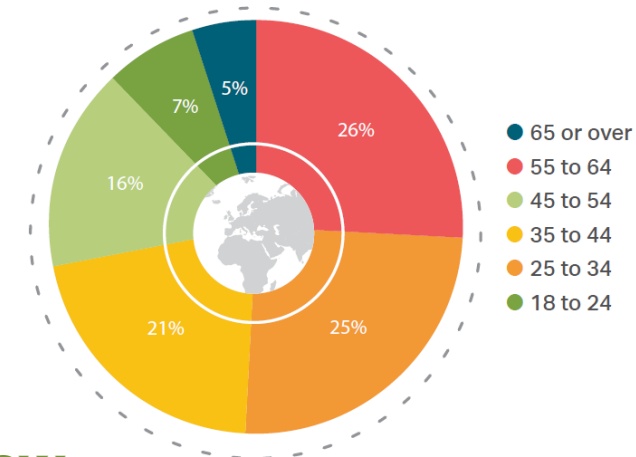

The facts

- From the same report, 91% of the sector thought the skill shortage and demographic crisis had already hit or was due to in the next few years.
- With 86% of skills shortage being seen in the engineering and project leadership.

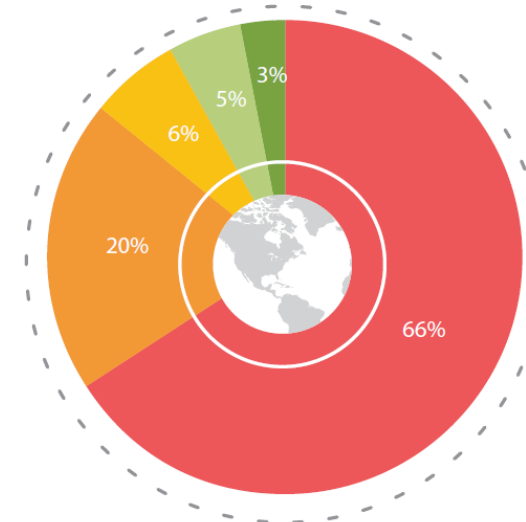
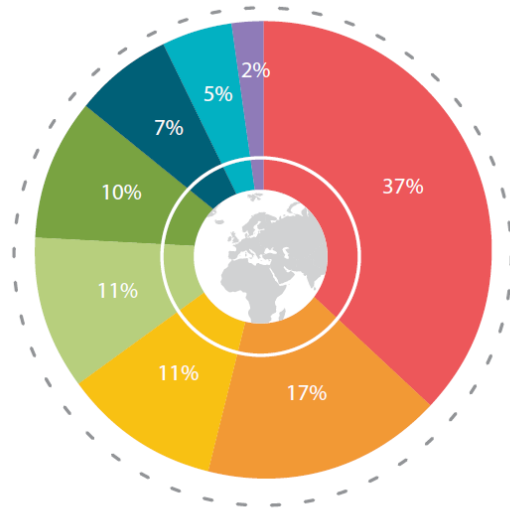

Government & CQI Data

- A recent government study outlined that the nuclear sector will need around **186,000** skilled recruits each year until 2024 to fill this skill gap and demographic crisis.
- Our own CQI figures from the sector also show 63% of NucSIG being aged 40 and over.



Our questions to you

- From the provided data it is essential that we start to provide urgent support and obtain interest in the profession and sector and we have the following 3 questions for you to answer.
 1. Why is it important to attract, encourage and support the next generation of Quality professionals in to industry including the nuclear sector?.
 2. If no action is taken to actively address the skills shortage and demographic issues, what do you think the nuclear industry and the profession would look like in 10 – 15 years?.
 3. What can we do as an institute to self-promote and help to inspire the next generation to join the Quality profession and sector?.

CQI's & NucSIG Views

- Can I please offer the views of Vince Desmond CQI CEO's and Amanda McKay the NucSIG chair.



Forward

- Some great view points and insight shared by both Vince and Amanda.
- The views inside NNG are also as equally important and we are honoured to have Howard Cooper as the NNG ambassador to provide support and guidance to the group and to share his opinions of the same questions.
- As an institute and as a sector we have the same fears, views and ideas in regards to the next generation.
- So to answer the question “What can we do to self-promote and help to inspire the next generation to join the Quality profession and sector?”, who are the NNG and what are their goals?

The NNG

The Next Nuclear Generation (NNG) has been set up and will work under the CQI and NucSIG banner.

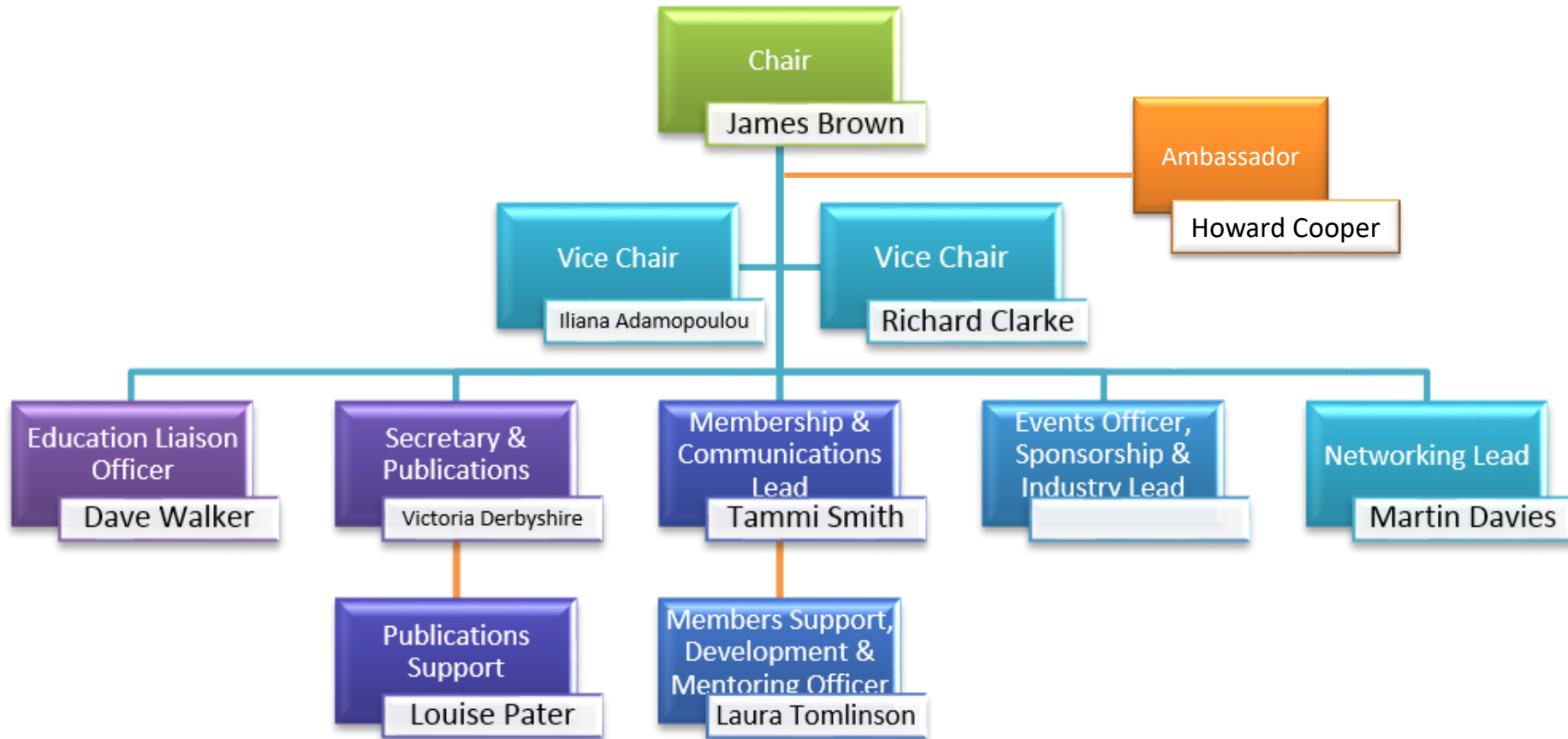

The NNG

The NNG aims to provide support to the next generation of professional within or outside of the sector for all personnel who are aged between 17 – 40.

The NNG shall be working with various personnel related groups



The NNG Aims

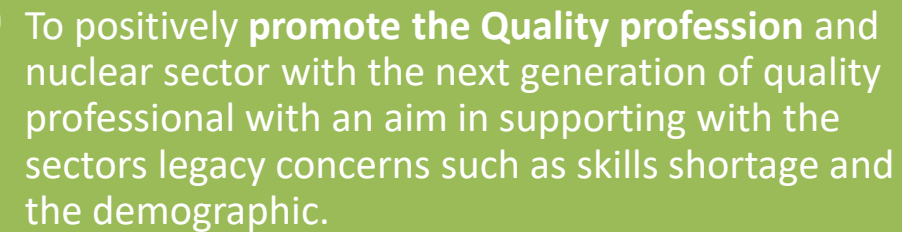

To positively **promote the Quality profession** and nuclear sector with the next generation of quality professional with an aim in supporting with the sectors legacy concerns such as skills shortage and the demographic.

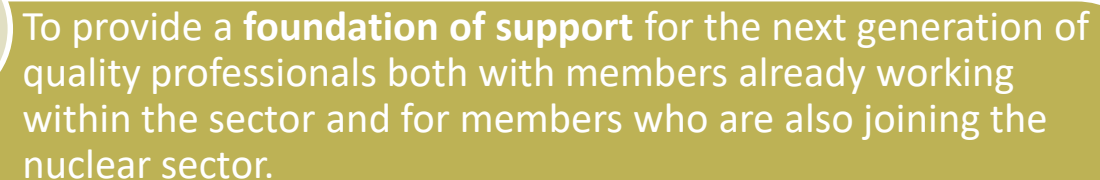

To provide a **foundation of support** for the next generation of quality professionals both with members already working within the sector and for members who are also joining the nuclear sector.



To facilitate **networking** opportunities for the purpose of offering education, support and **knowledge sharing**.

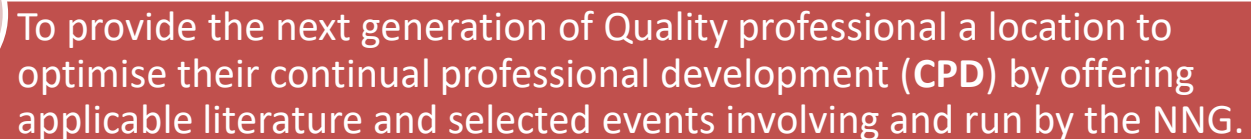

To provide the next generation of Quality professional a location to optimise their continual professional development (CPD) by offering applicable literature and selected events involving and run by the NNG.

The NNG Objectives

1

To communicate with all levels to obtain interest within the nuclear sector and quality profession with various groups so to provide **support** by the use of the CQI and **Nuclear Competency Framework**.

2

To **innovate** and trail blaze new ideas and concepts to aid and support NucSIG, CQI and the nuclear sector as a whole.

3

To establish working relationships and **network** with other next generation groups to obtain and provide support for all sector industries at next generation level.

4

To arrange and communicate a series of **events** run by and involving members of the NNG via the new NNG section of the NucSIG web site.

5

To **support NucSIG** as required including the completion of allocated tasks or structured working activities and to propose related works to NucSIG for completion.

NNG progress

So what's next for the NNG for the up and coming year?

To obtain as much interest as possible for the group so we can start to inspire, support and encourage the next generation of quality professional.

To commence communication with all on all available platforms inclusive of twitter, Facebook and LinkedIn etc

To arrange and complete NNG events on related and applicable topics using various platform such as webinars and speed learning etc.

To support CQI and NucSIG as required as a group.

Official NNG launch of the group
(The big "L")

To network with other associated groups such as the YNSDF, YGN and NGN to collaborate and support the sector as a whole.

To provide the NNG members with a system for ongoing mentoring and support.

NNG need You !



**NUCLEAR
NEXT GENERATION**
**NEED
YOU**

NNG need You !

- What can you do to help?
 1. You can actively promote NNG within your businesses and related supply chain.
 2. Encourage next generation personnel within your business or the supply chain to join the NNG, NucSIG and the CQI as active members.
 3. To provide NNG information to potential members and ask them to contact us via the NNG email address nng@quality.org to become members.
 4. Look out for and share NNG communications on all platforms in future and offer your opinions, views and ideas on related subjects being communicated via Twitter, LinkedIn and Facebook etc.
 5. To consider supporting and sponsorship of future NNG events and related works.
 6. To help us fully understand how best to promote, inspire and encourage the next generation of quality professional in to the profession and sector by attending the related workshop later on this afternoon.

Thanks from the NNG

(Over to Caroline Whitson from the CQI)



LUNCH

<https://youtu.be/YwFUGeuZspg>



Feedback from
previous
meeting & NQK
update

Richard Hibbert

Richard Hibbert
Consulting

Vice-Chair NucSIG



NUK Revision

Harwell March 2019

Richard Hibbert

Vice Chair, CQI Nuclear Special Interest Group

NQK Overview

- The Nuclear Quality Knowledge (NQK) is a nuclear industry guidance document that has been written to complement the CQI Body of Quality Knowledge.
- NQK aims to highlight the differences or nuances that a quality professional will experience on joining or supplying the nuclear sector.
- The last major revision of the NQK was undertaken in 2013.
- The NQK can be accessed on the NucSIG part of the CQI website (<http://cqinucsig.wixsite.com/nucsig/quality-knowledge>) and can be downloaded as a pdf document.
- Chapter 4 covers Project Management.

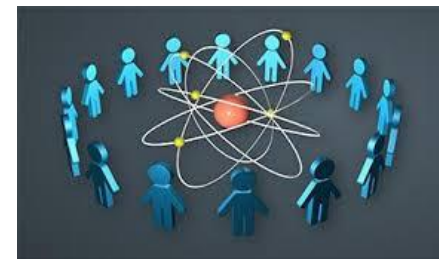

Update of NQK

- A review of NQK 2013 was carried out in early 2018. It was recognised that there have been some significant industry developments since 2013. In addition, many of the references in NQK 2013 are out of date.
- A number of different update options were considered including a change of structure. It was decided that the most practical way forward was to retain the current structure and focus on updating the content and making sure that all references are current and that all links work properly.
- Subsequent review has led to more extensive editing of some chapters.
- The update is now largely complete.



Further Development of NQK

- A more extensive revision of the NQK is needed:
 - Chapters are generally too long.
 - Limited use of pictures and diagrams.
 - Readability and structure can be improved.
 - Some chapters are biased towards the experience of the main author and do not provide a balanced industry overview.
 - Alignment with CQI competency framework needs to be considered.
- Involve the Next Generation (NNG) in the revision.
- Future version needs to be suitable for smartphone use.



Project Management Chapter Feedback

- NucSIG Project Management event March 2018.
 - Heavy Sellafield bias. The chapter needs to be more general with a wider contribution base.
 - Refer out to generic PM sources.
 - Improve format to make more useable.
- Balfour Beatty review as part of NQK revision.
 - No description of project management process.
 - Fundamentals of project management missing.
 - Too biased towards Sellafield.
 - Sections could be better organized.
 - Reference BS ISO 21500:2012 and internationally recognized project management approaches.



Current Revision of Chapter 4

- Short description of project management process included.
- Additional references added:
 - BS ISO 21500:2012 Guidance on project management.
 - Project Management institute (PMI) A Guide to the Project Management Body of Knowledge (PMBOK® Guide), sixth edition 2017.
 - International Project Management Association (IPMA) Standards.
- Some editing carried out to try to reduce Sellafeld bias.



Future Update of Chapter 4

- Current revision of Chapter 4 only partly addresses feedback issues raised. Review comments on this Chapter will needed be considered again in next revision of NQK.
- A further review of Chapter 4 will be carried out by NNG.
- All users of the NQK are welcome to give feedback as an input into the next update.





WORKSHOP

How do we bring Quality in Nuclear into the 21st Century with the main focus of attracting young talent?



Feedback from
Workshop groups
and discussion

How do we bring Quality in
Nuclear into the 21st Century
with the main focus of
attracting young talent?



Wrap up & Questions

Amanda McKay

Quality Director Major Projects/Nuclear Quality
Director

Balfour Beatty

Chair Nuc-SIG